

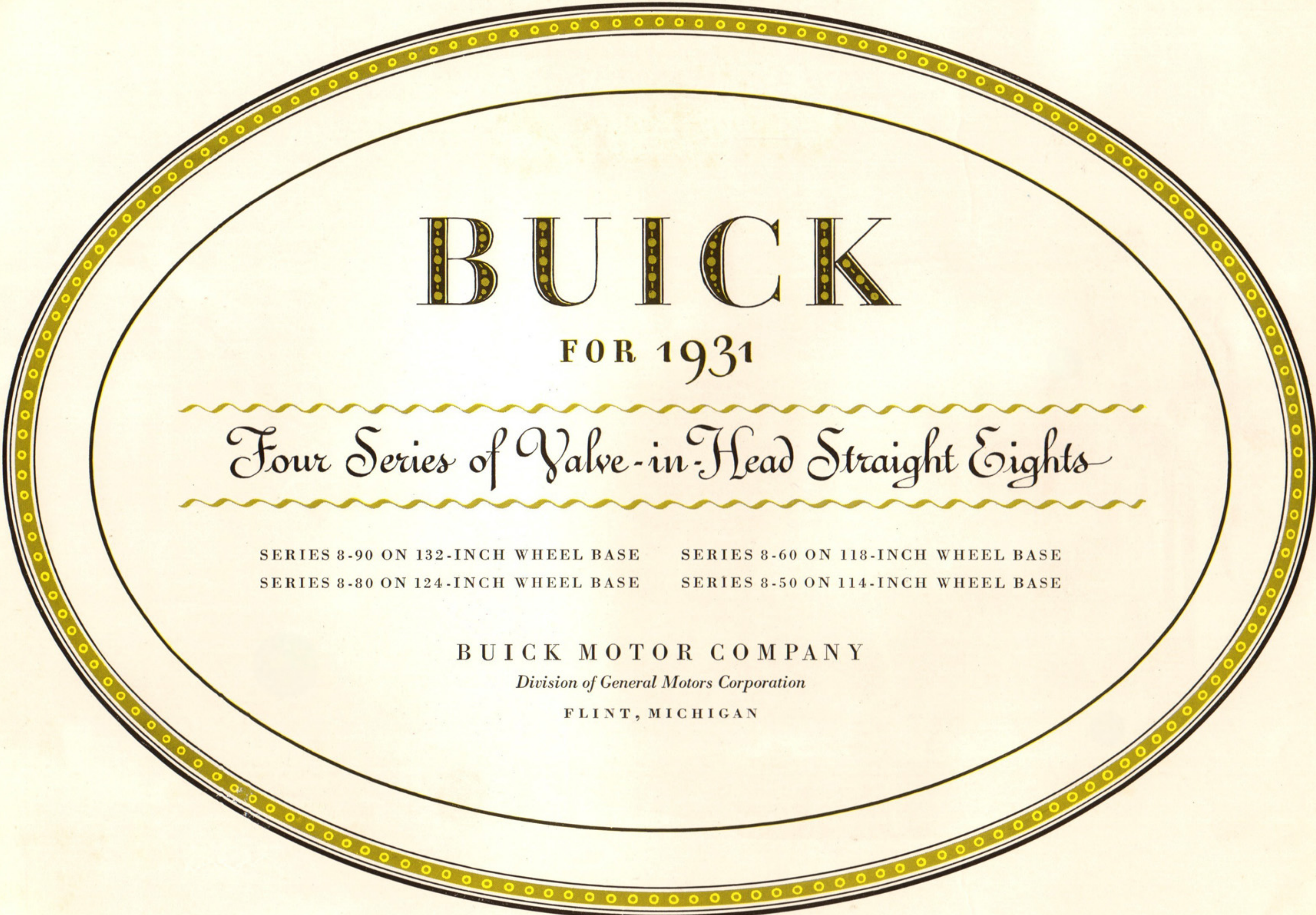

*Buick*  
*for 1931*  
*Four*  
*Straight Eights*



BUICK

FOR 1931

*Four Series of Valve-in-Head Straight Eights*

SERIES 8-90 ON 132-INCH WHEEL BASE

SERIES 8-60 ON 118-INCH WHEEL BASE

SERIES 8-80 ON 124-INCH WHEEL BASE

SERIES 8-50 ON 114-INCH WHEEL BASE

BUICK MOTOR COMPANY

*Division of General Motors Corporation*

FLINT, MICHIGAN

**BUICK VALVE-IN-HEAD STRAIGHT-EIGHT ENGINE**

For 1931, Buick is building Eights and Eights only—Valve-in-Head Straight Eights built on the same basic principles that Buick has followed for more than 27 years. Here is smoothness with no sacrifice of power, and dependability that only time-tested principles can assure. Here is the greatest engine that Buick has ever built.

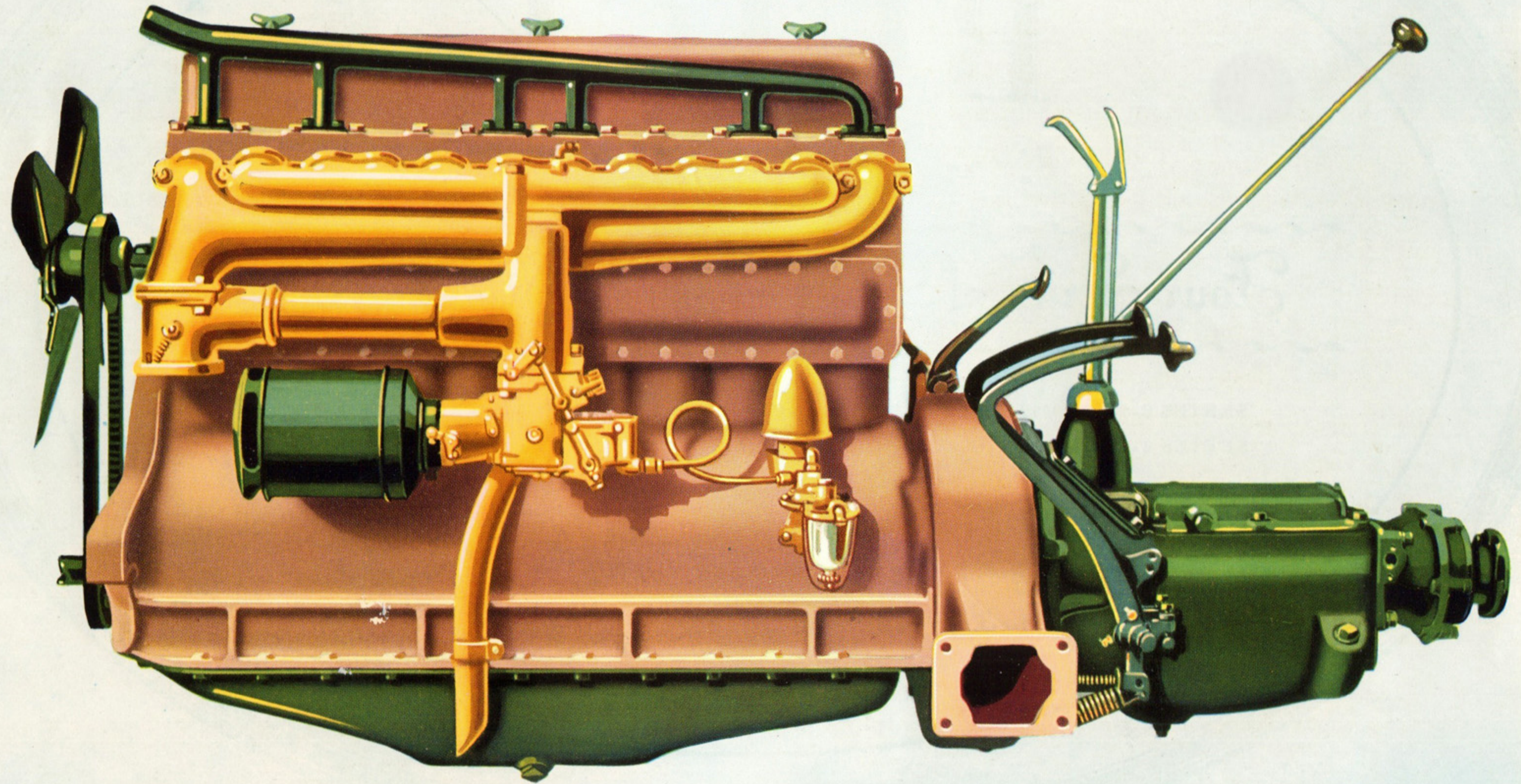

## BUICK VALVE-IN-HEAD STRAIGHT EIGHTS FOR 1931

**E**VERY one of the twenty Buick models for 1931 is a Valve-in-Head Straight Eight. For twenty-seven years, Buick has been developing the Valve-in-Head principle. It carried this principle to the furthest possible development in a six-cylinder engine. And now, opening a wonderful new field for advancement, it applies this time-proved principle to a straight-eight engine, and without compromise, throughout the entire line, offers for 1931 Eights and Eights only.

This decisive step is taken because the Valve-in-Head Straight Eight, as Buick builds it, is fundamentally a better engine and a logical culmination to the steady development that Buick has been carrying on for more than a quarter of a century.

Without question, these new Buick Valve-in-Head Straight Eights, individually and collectively, are the greatest values that Buick has ever offered. They meet every motoring need. Thousands who have always wanted a Buick will now find within their reach not only a Buick, but a Valve-in-Head Straight-Eight Buick. And other thousands, who have been

accustomed to paying higher prices for cars, will now obtain in a Buick Valve-in-Head Straight Eight complete motoring satisfaction at a saving of hundreds of dollars.

These new cars will establish Buick leadership still more firmly. Already, two people buy Buicks to one who buys any other make of car in or above Buick's field. In state after state and city after city, Buick wins 30 to 50 of each 100 sales in its class. The remainder is shared by fifteen other makes of cars. Seven hundred thousand more people drive Buicks than any other car priced above \$1200. And of the great army of 1,500,000 Buick owners, more than four out of five—88 per cent—buy Buicks again and again.

Better Buicks each year for twenty-seven years explain this outstanding leadership. And the new Buicks for 1931 afford stronger reasons than ever for this overwhelming public preference.

Extra power, due to the Valve-in-Head principle and Straight-Eight design, is now combined with the smoothness that comes from the eight-cylinder engine. Consequently, the 1931 Buicks will travel at speeds of 75 to 80 miles an hour;

they are not only amazingly smooth at all speeds, but they also take the hills with ease and accelerate readily in high gear so that a minimum of gear shifting is required.

Among scores of developments in the new cars, two are particularly outstanding—the Buick Syncro-Mesh transmission in the Series 8-90, Series 8-80, and Series 8-60; and the Buick Oil-Temperature Regulator in all models.

The Syncro-Mesh transmission makes gear shifting delightfully easy and absolutely eliminates the clashing of gears.

The Oil-Temperature Regulator prevents the engine oil from over-

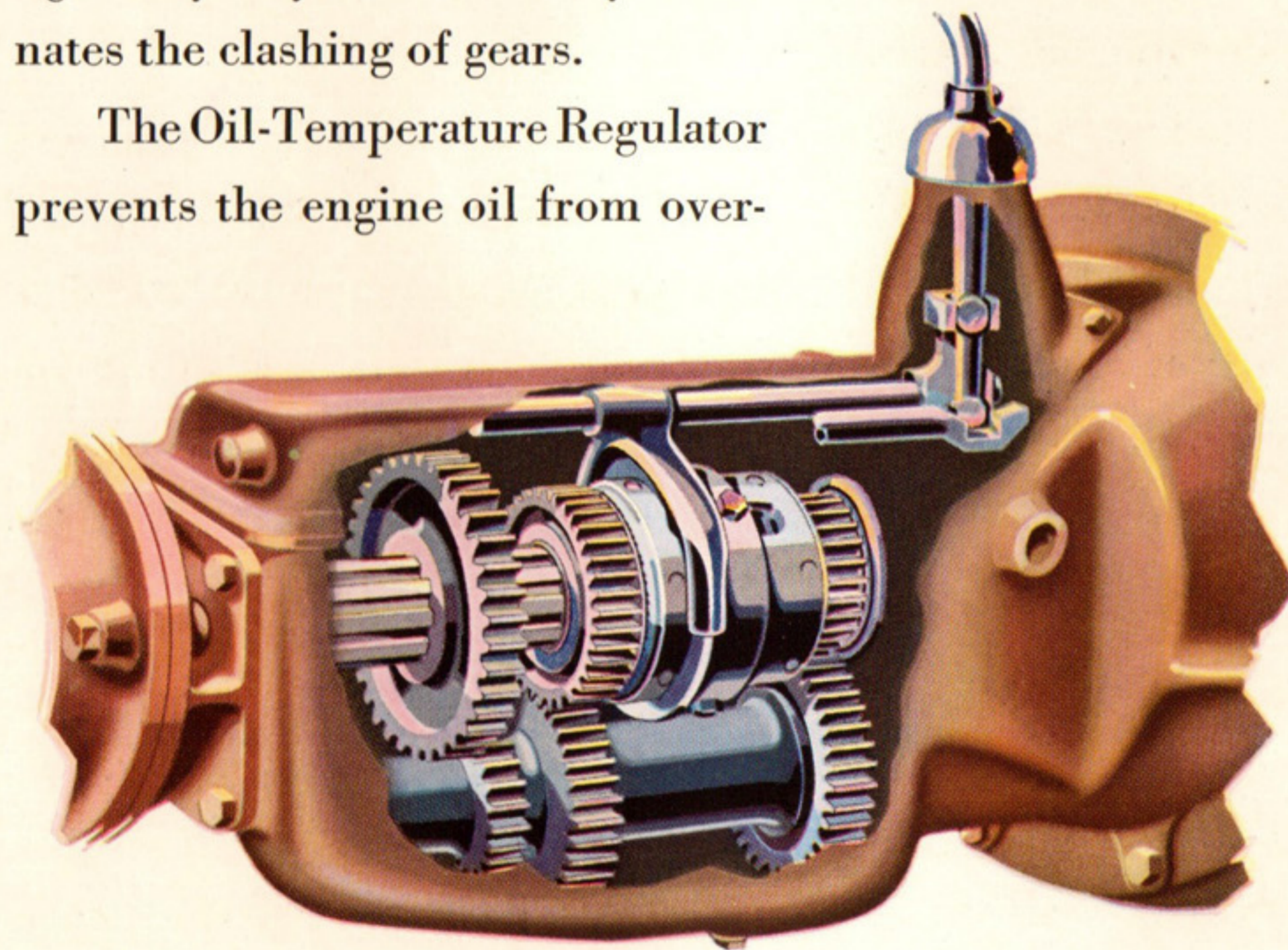

*Buick Syncro-Mesh Transmission*

heating, even when the car is driven at high speed for mile after mile. In cold weather, the Regulator warms the oil quickly, thus assuring efficient engine performance immediately after starting the motor.

Complete insulation of the driving compartment, shutting out all sound and making the cars delightfully quiet, is another important development.

All units of the cars have been developed in line with the increased power and speed. The frame, in particular, is much sturdier, the cross members being stronger and mounted in a new and more rigid manner. Of the whole chassis it can be truthfully said that none better could be constructed, no matter how much money might be expended on it.

The bodies by Fisher are mounted in such a way that they form a unit with the chassis, greatly increasing smoothness. Their interiors are wholly new in appearance, being finished in the finest grades of broadcloth, mohair plush, and whipcord, and with genuine leather in the open models.

All the basic features of former Buicks are retained. In combination with new developments they make the 1931 Buick Valve-in-Head Straight Eights the greatest fine car values ever offered at anywhere near Buick's price.

## DE LUXE CARS OF UNUSUAL CHARM—BUICK SERIES 8-90

**T**HE luxury and refinement of a charming home are paralleled in the interiors of the Series 8-90 De Luxe Buick models. In appearance they are wholly new and reflect the very latest trends in colors and trimming.

Individual taste is given exceptionally free play in the choice of upholstery. The finest of broadcloths, mohair plushes, and whipcords in rich, pleasing colors are available for each closed model; and in the open models smart appearance is combined with serviceability by the use of genuine leather.

Against these pleasing backgrounds, the new Buick instrument panel, the mahogany-finish garnish moldings, the rear corner lamps in closed models, and the door handles, window lifts, and other body hardware, all of special Buick design, are shown to the best advantage. Velvet carpets in the rear compartments and silk-finish window curtains add to the charm.

Pleasing appearance is supplemented by luxurious comfort, which is due not only to the spaciousness of the cars and deep, soft seats but to the basic construction of the Fisher

bodies. Scientifically braced at every point where strain occurs and mounted so that they are a unit with the chassis, the bodies afford amazing riding ease at every speed and are free from noise and rumble.

Comfort is further promoted by use of an insulated rubber mat in the driving compartment, insulation on the dash, and insulation around the pedals and controls—completely shutting out drafts.

The insulation also absorbs sound so that the interiors are unusually free from noise of all kinds.

Other features of comfort and convenience are the Fisher vision-ventilating windshield, set at an angle to eliminate glare, screened ventilator in each side of the cowl, adjustable driving seats, arm rests in rear seats, foot rests, assist cords, and many others.

To all these advantages are added the smooth-flowing power from the Buick Valve-in-Head Straight-Eight engine, the amazingly easy gear shifting afforded by the Buick Syncro-Mesh transmission, and the improved performance resulting from all Buick's other developments.

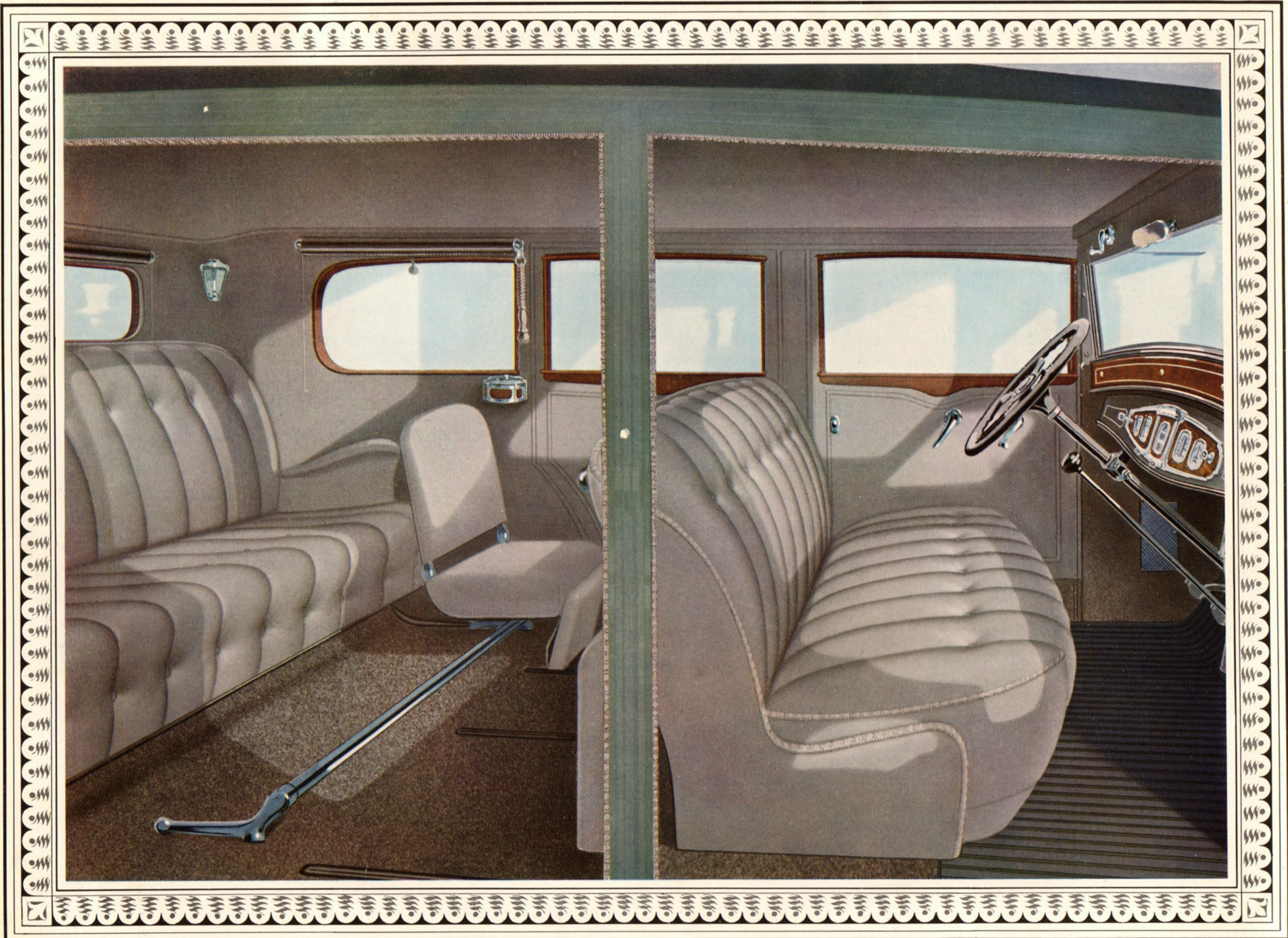

BUICK SEVEN-PASSENGER SEDAN

*Model 8-90 on 132-inch wheel base*

The ample capacity of this Buick makes it an ideal car for family use. It has side corner lights that turn on when right-hand rear door is opened. Its seats are wide and luxuriously deep, and the comfortable auxiliary seats fold out of the way. Assist cords, foot rest, and arm rests on the rear seat are other features.

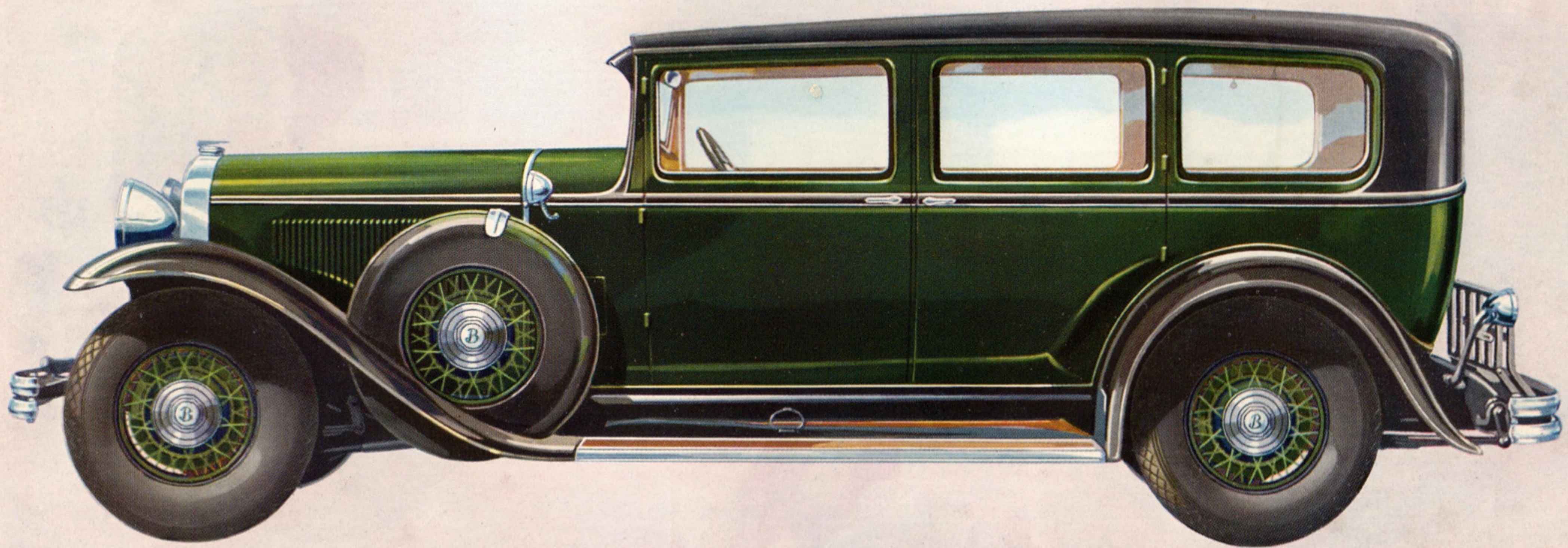



BUICK SEVEN-PASSENGER LIMOUSINE

*Model 8-90L on 132-inch wheel base*

The plate glass partition dividing the driving compartment from the passenger compartment in this Limousine may be lowered to convert the car into a Sedan. The front compartment is trimmed in morocco grain black leather. There is a telephone and many other features of convenience.

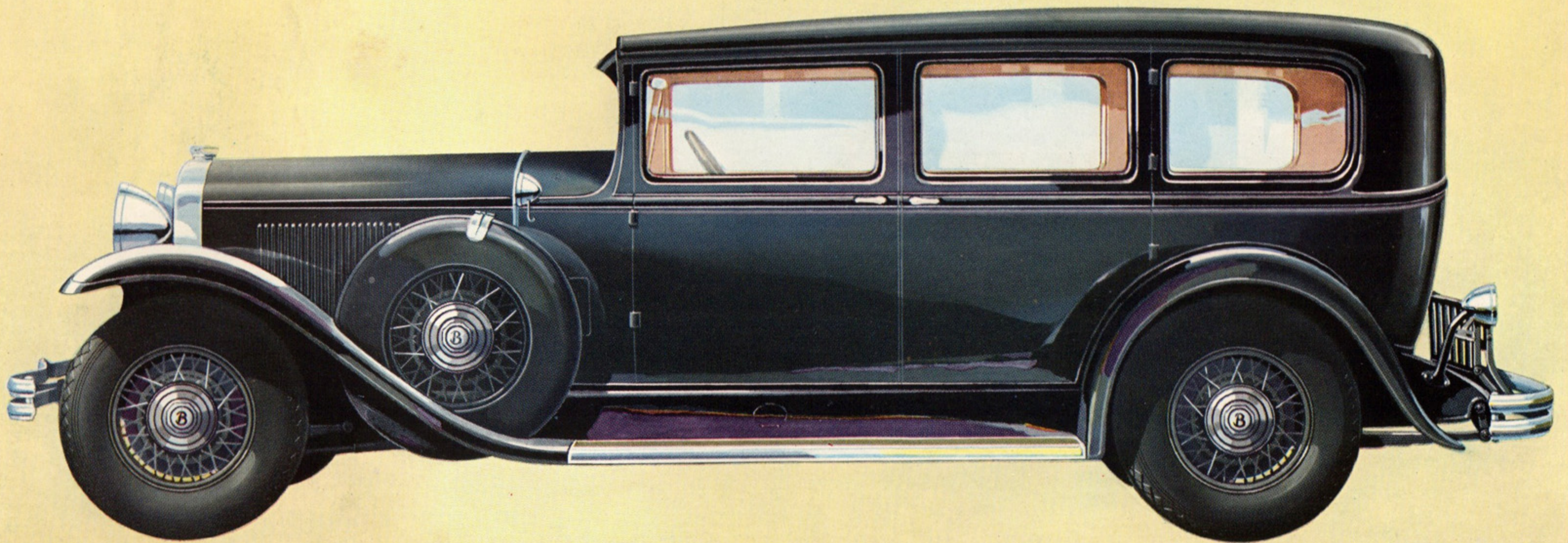

BUICK FIVE-PASSENGER FOUR-DOOR SEDAN

*Model 8-91 on 132-inch wheel base*

Trimmed in broadcloth, mohair plush, or whipcord, like the other Series 8-90 closed models, this Buick Sedan offers a maximum of motoring satisfaction. With the other closed models it has a Fisher VV type, nonglare windshield, insulated driving compartment, adjustable driving seat, and hardware of special Buick design.

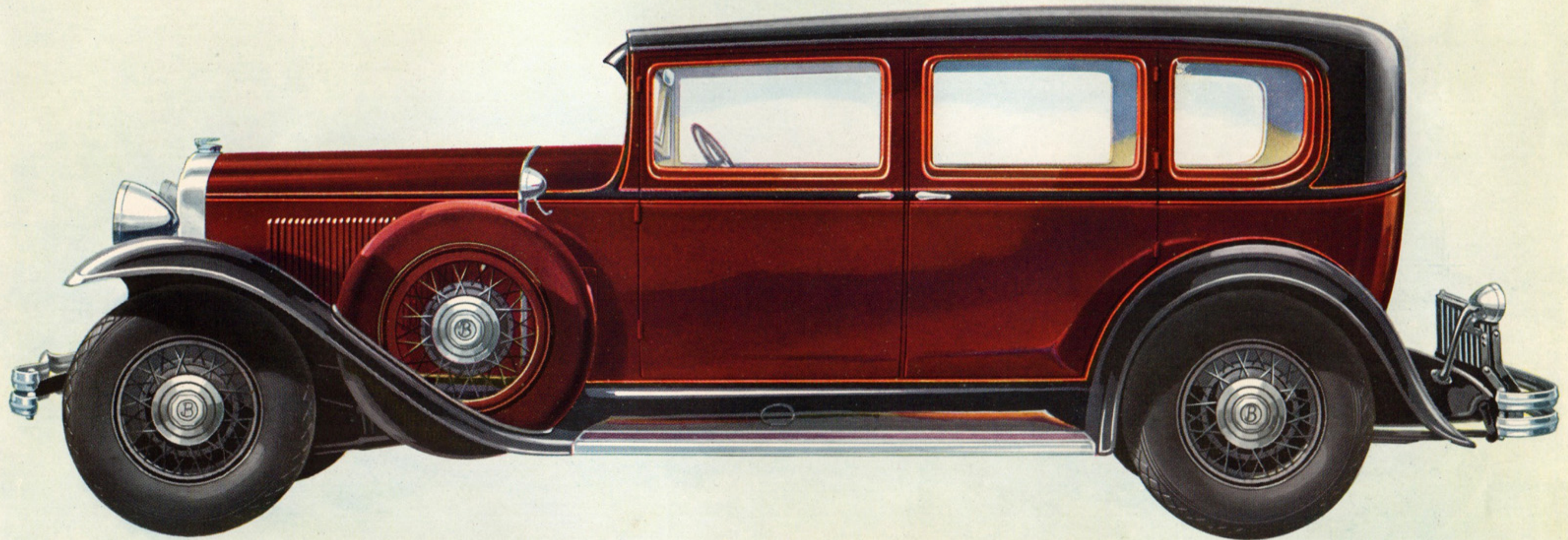

BUICK FOUR-PASSENGER SPORT ROADSTER

*Model 8-94 on 132-inch wheel base*

The long, low lines of this car bespeak its spirited performance. It is finished in genuine leather and has plated deck bars, chrome-plated windshield, and other smart details of appearance. The rear deck seat, easily accessible by aluminum steps, is fully trimmed. The front seat is adjustable; the top can be completely detached.

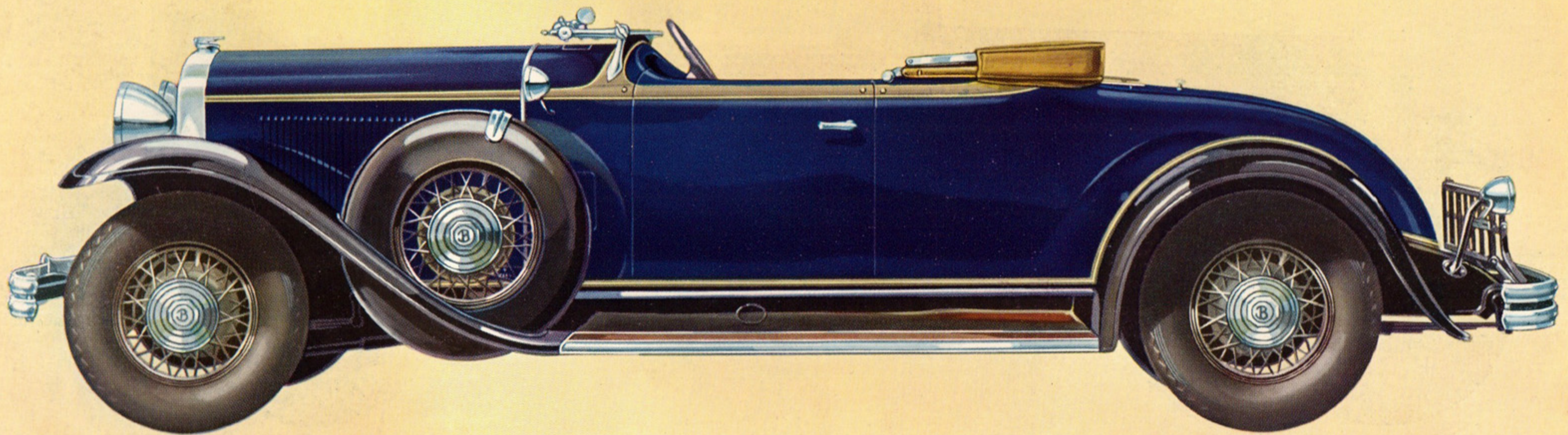

BUICK SEVEN-PASSENGER PHAETON

*Model 8-95 on 132-inch wheel base*

An unusually spacious car, this attractive open model with streamline body has a number of distinctive features such as a light in the back of the front seat, a nickel-plated combination robe rail and assist handle, a tool pocket with lock in the left front door, and extra pockets in the sides of the tonneau.

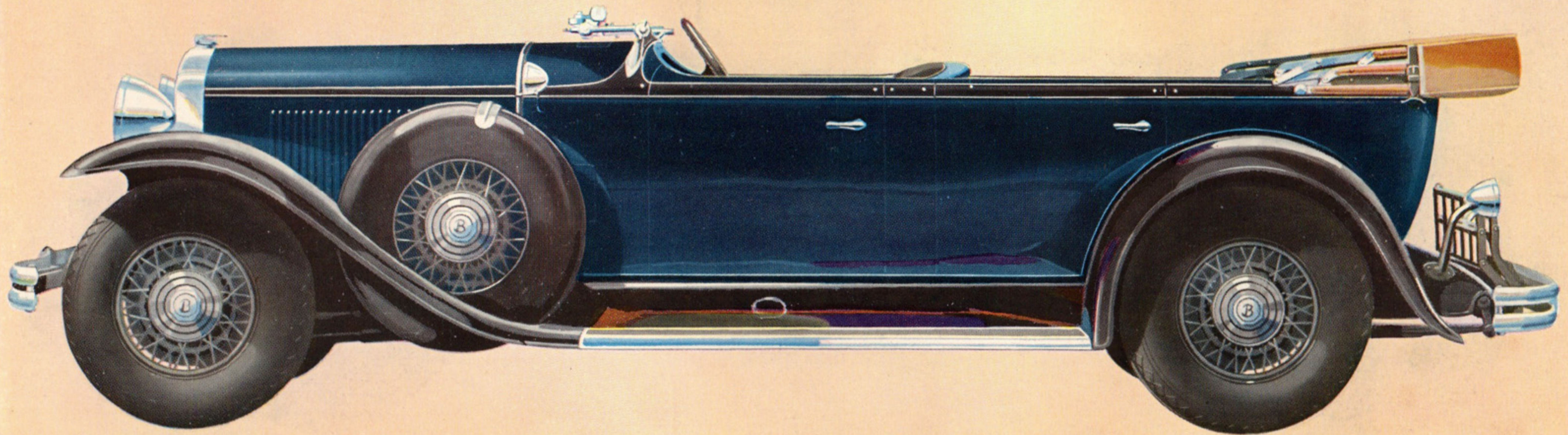

BUICK FIVE-PASSENGER COUPE

*Model 8-96 on 132-inch wheel base*

Because it combines the trim, smart lines of a Coupe with five-passenger carrying capacity, this car is one of the most popular Buick models. Both the adjustable driving seat and the front passenger seat are hinged. The rear deck has ample capacity for luggage. The deck door is equipped with a self-balancing hinge.

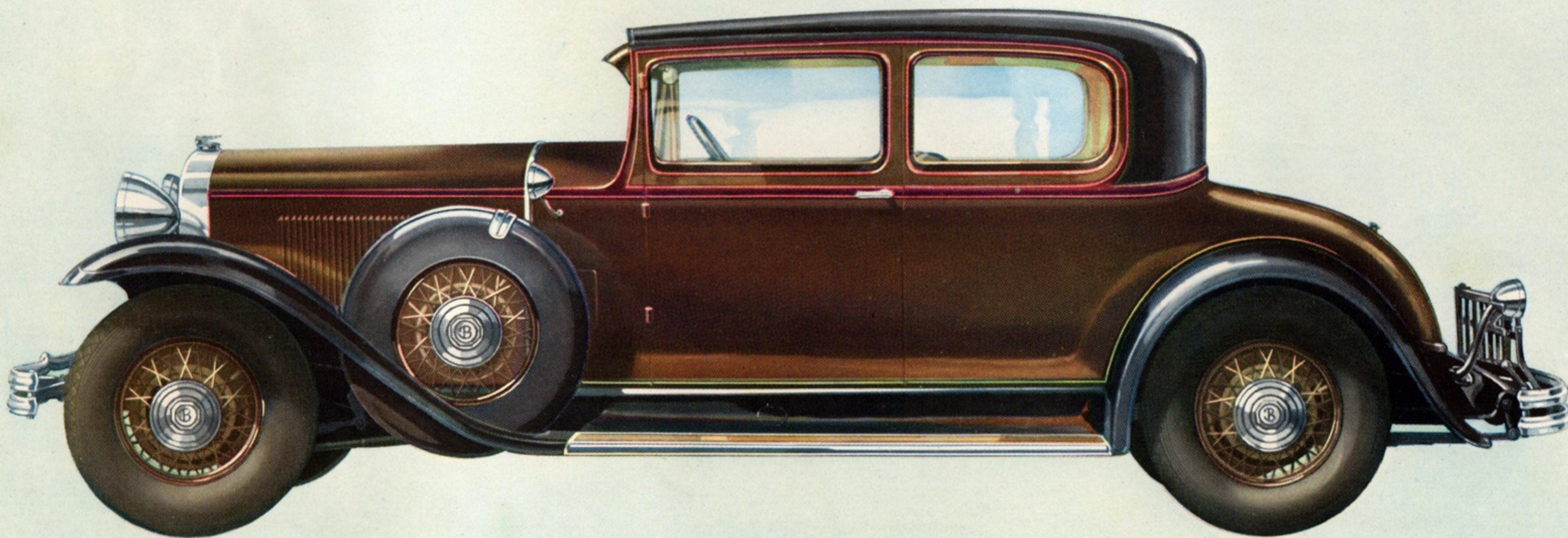

BUICK FOUR-PASSENGER COUNTRY CLUB COUPE

*Model 8-96S on 132-inch wheel base*

Stylish and distinctive in appearance, this Country Club Coupe is equally appealing for its performance and comfort. The large driving compartment has an adjustable driving seat with a special pocket in the back for small articles. The rear deck is completely trimmed and has a wide, comfortable seat.

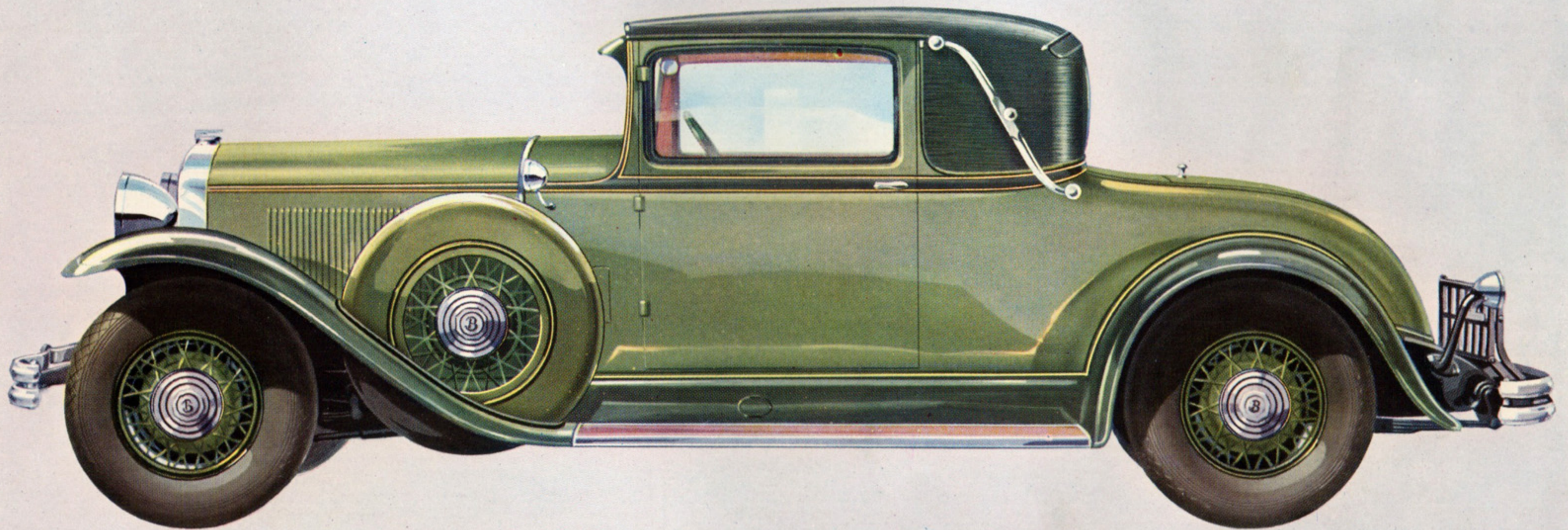

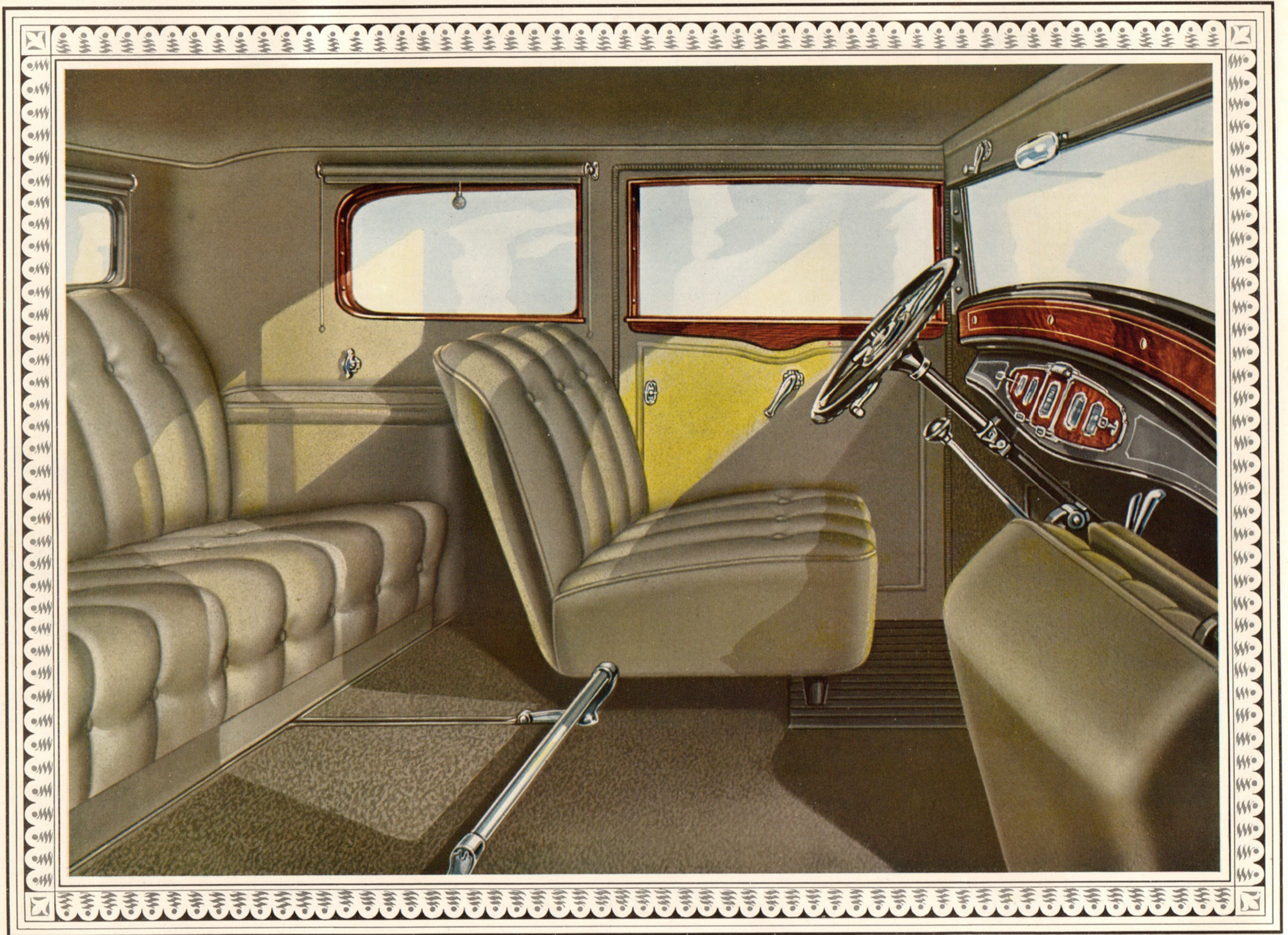

## CARS THAT OFFER ROOMY COMFORT—BUICK SERIES 8-80

**S**PACIOUSNESS is a fundamental requirement for motoring comfort and it is provided to an unusual degree in the Series 8-80 Buicks, as well as in all the other Buick models. The long wheel base allows provision for ample leg room, and the Buick double-drop frame, without sacrificing road clearance, permits designing of the bodies so that they afford an unusual amount of head room, and yet are low and smart in appearance.

Roominess in the driving compartments is further increased by the design of the Buick Syncro-Mesh transmission, which permits placing the gear-shift lever well forward under the cowl where it does not interfere with the feet of the driver or front seat passenger.

The designers of the bodies have made the most of these fundamental advantages and have overlooked no detail that could contribute to comfort or convenience. The seats are wide and deep and are built over coils of special springs, covered by thick padding, carefully shaped and tailored to assure utmost comfort.

The upholstery is mohair plush or whipcord, according

to the preference of the buyer, and has button-style trimming. The lining for the sides and top is colorful and attractive and forms a fitting background for the hardware of special Buick design—the dome light, the new instrument panel, and other features.

As in all the Buicks, the accelerator is the treadle type covered with rubber. It permits a restful driving position of the foot and will not scuff shoes—two advantages that will be particularly appreciated by women.

Similar thoughtful provision for comfort will be found in many other details, such as the assist cords, arm rests, and foot rest in the sedan; screened side cowl ventilators, adjustable driving seat, Fisher VV windshield, set at an angle to eliminate glare; and the new type rear-vision mirror with rounded ends.

Powered by a Buick Valve-in-Head Straight-Eight engine and equipped with the Buick Syncro-Mesh transmission, Oil-Temperature Regulator, and other Buick mechanical developments, the Buick Series 8-80 offers everything that can be desired in the fine car of today.



BUICK FOUR-PASSENGER COUPE

*Model 8-86 on 124-inch wheel base*

A comfortable seating arrangement for four passengers makes this model an ideal all-purpose car, without sacrificing the special advantages of a Coupe. The front passenger seat folds under the shroud. There is a package compartment behind the driving seat, and the spacious rear deck has a large door with locking handle.

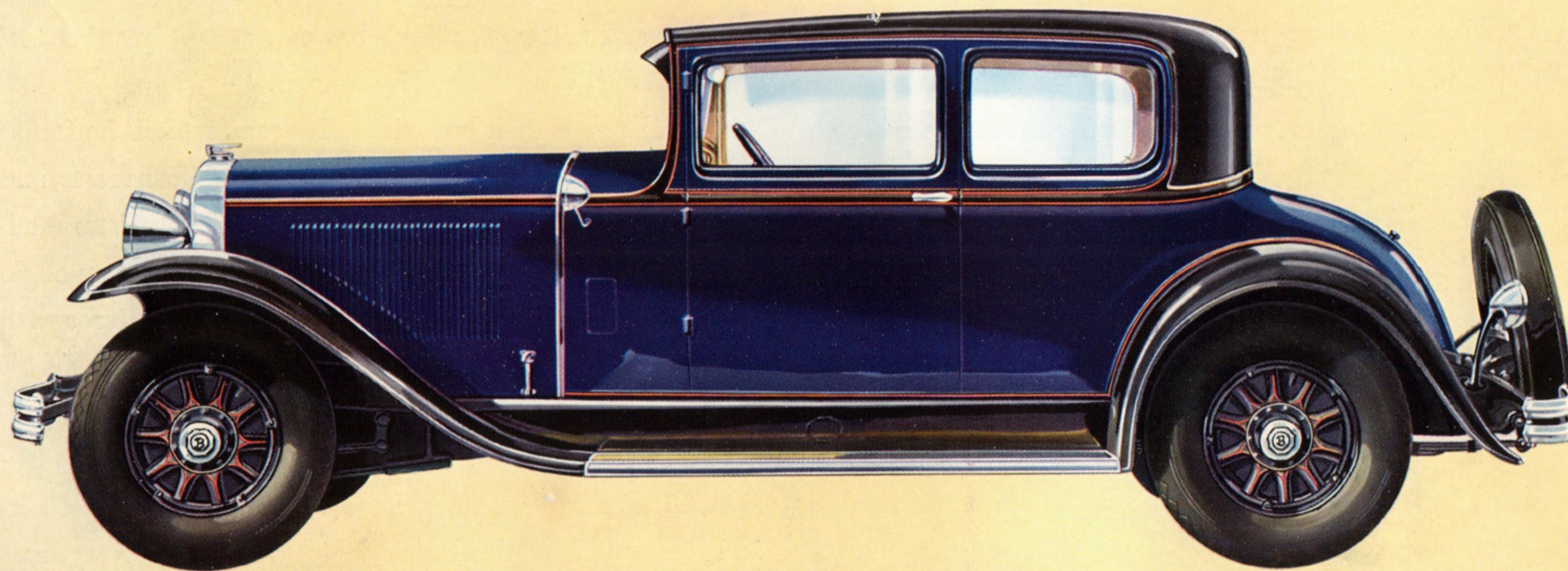

BUICK FIVE-PASSENGER FOUR-DOOR SEDAN

*Model 8-87 on 124-inch wheel base*

A remarkably practical Sedan—an abundance of room for five people. Button-style trimming in mohair plush or whipcord makes the interior notably pleasing in appearance. Foot rest, arm rests for the rear seat, silk-finish curtains, and a velvet carpet in the rear compartment are a few of many attractive appointments.

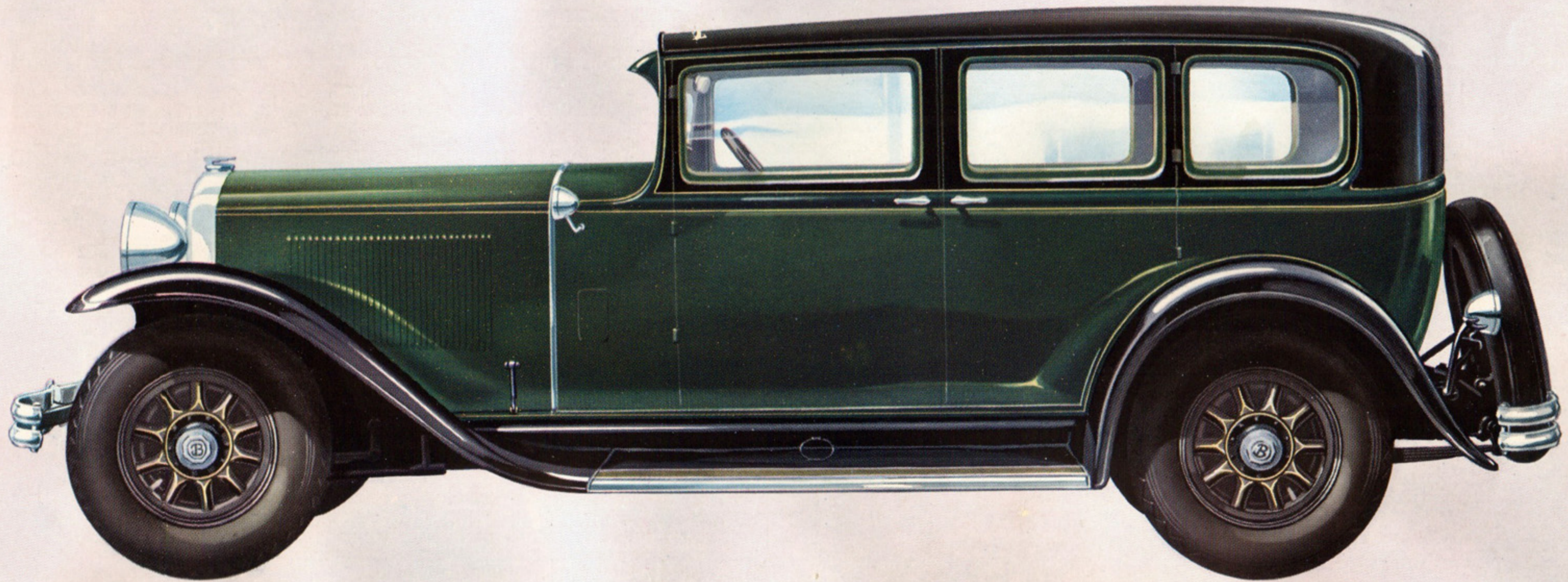

## FOR EVERY MOTORING NEED—BUICK SERIES 8-60

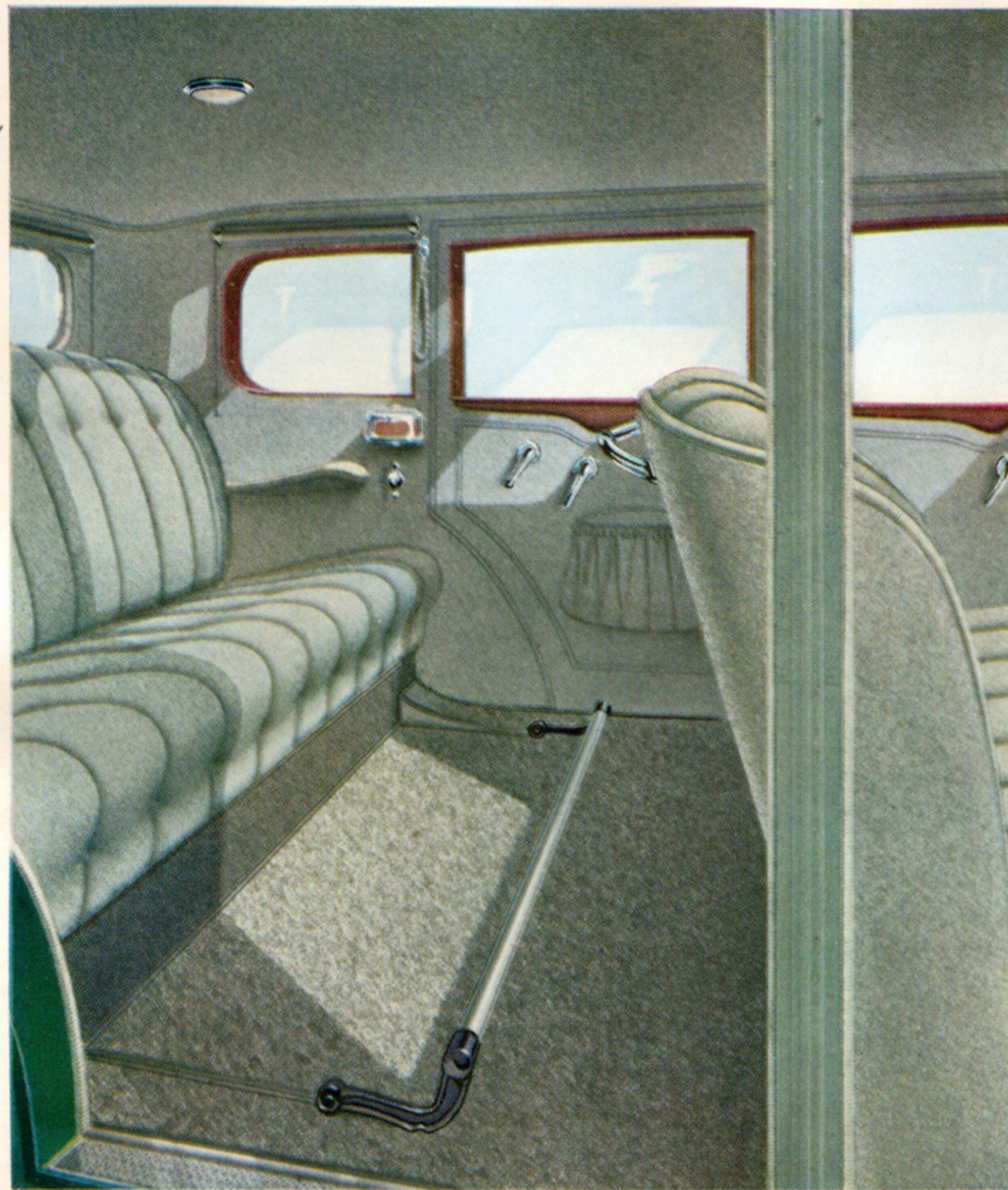

CONSISTING of a Four-Door Five-Passenger Sedan, Business Coupe, Special Coupe, Phaeton, and Sport Roadster, the Buick Series 8-60 on a 118-inch wheel base offers a car for almost every motoring need. Each model has its special advantages, but all are alike in the smartness of their appearance, the use of pleasing, new color combinations, and the comfort and beauty of their interiors.

A choice of cloth and of colorful mohair plushes is offered for the upholstery of the closed models, and velvet carpets are provided for the rear compartments. The floor of the front compartment in both open and closed models is covered by a heavy insulated rubber mat which, in conjunction with insulation on the dash and around the pedals and controls, completely shuts out drafts and sound.

All the body hardware is of special Buick design to harmonize with the pleasing atmosphere established by the upholstery and lining. The instrument panel is the new Buick design, very pleasing in appearance, and both directly and indirectly lighted.

Open models share in all the refinements that have been

developed for the closed cars. Because they are more exposed to the weather, especially when the tops are down, they are upholstered in genuine leather of a pleasing grain and color, with the smart, plain-style trimming. The seats are low, with cushions and backs shaped to provide maximum riding comfort, and they are built over deep, soft springs.

The tops are made of heavy, double-texture, waterproof material in serviceable colors, and are built over natural wood bows. Their lines are long and low and they fold compactly when lowered. Close-fitting side curtains, specially designed for quick attachment and removal, provide complete protection in bad weather.

The windshields have chromium-plated frames and can be folded down to permit full enjoyment of the breeze. Ventilators, both on the tops and the sides of the cowl, effectively cool the driving compartment.

The design and finish of the rear deck compartments of Buick Sport Roadsters and Special Coupés afford additional evidence of the care and skill that have been employed to assure complete motoring satisfaction. The seats are deep and comfortable and the compartments are completely trimmed and have rubber floor mats. Aluminum step plates afford

easy access to the seat. The rear window of the Special Coupe can be lowered, and the center back curtain of the Roadster can be opened to permit conversation with passengers in the driving compartment.

These are features that can be easily seen. But just as important, though not so obvious, are the developments that have been effected in the concealed parts of the open and closed bodies. So accurately are the bodies fitted to the chassis that they form a unit with it, adding a smoothness to the riding quality of the car at all speeds that words cannot adequately describe.

And at every point where extra strain occurs because of increased power and speed extra strength has been added. The roofs of closed cars are fastened to the body with new type braces that strengthen the whole body construction. And similar extra bracing is used at many other points so that bodies are fundamentally better than ever before, offering to the motorist the greatest values in Buick history.

Whatever Buick model a motorist may choose, he is assured of maximum motoring comfort and convenience, combined with smooth, powerful performance such as only a Buick Valve-in-Head Straight-Eight engine can give.

BUICK FOUR-PASSENGER SPORT ROADSTER

*Model 8-64 on 118-inch wheel base*

With top down or detached and windshield folded forward, this spirited Buick offers maximum warm weather enjoyment. At other times it can be quickly and easily made snug by means of close-fitting side curtains. The upholstery is genuine leather, attractively grained and colored, trimmed in plain style.

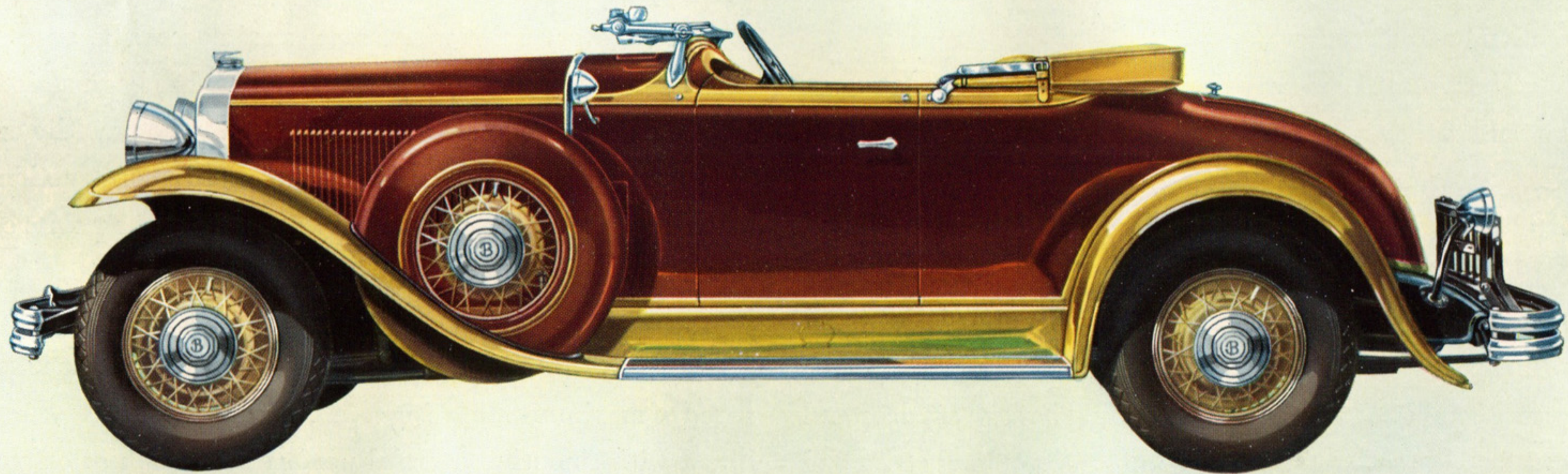

BUICK FIVE-PASSENGER PHAETON

*Model 8-65 on 118-inch wheel base*

Thousands love the open car—this smart Phaeton has lustrous body colors. Genuine leather upholstery in plain trim style, a foot rest, arm rests in the rear seat, an attractive carpet are typical of the complete appointments. The top has new smart lines, built over wood bows with chromium-plated sockets.

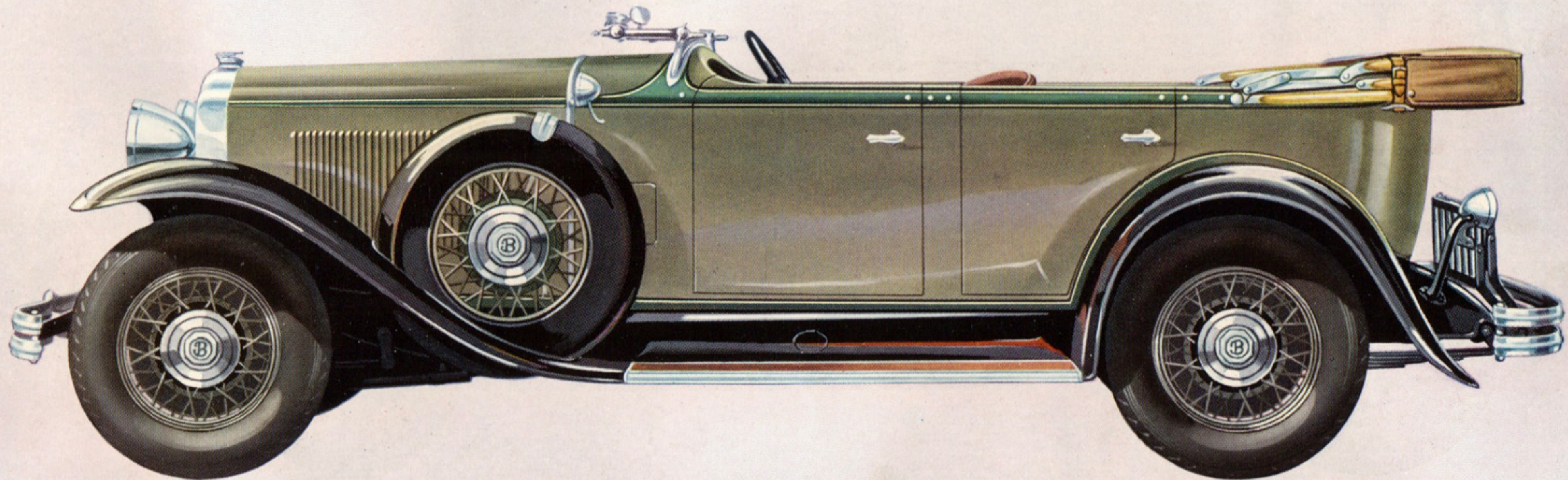

BUICK TWO-PASSENGER BUSINESS COUPE

*Model 8-66 on 118-inch wheel base*

The comfort and dependability of this model make it exceptionally adaptable for business use. The deck door is wide and hinged at the front so that the deck is very accessible for carrying luggage or other articles. Mohair plush or cloth upholstery is available, both being serviceable as well as beautiful.

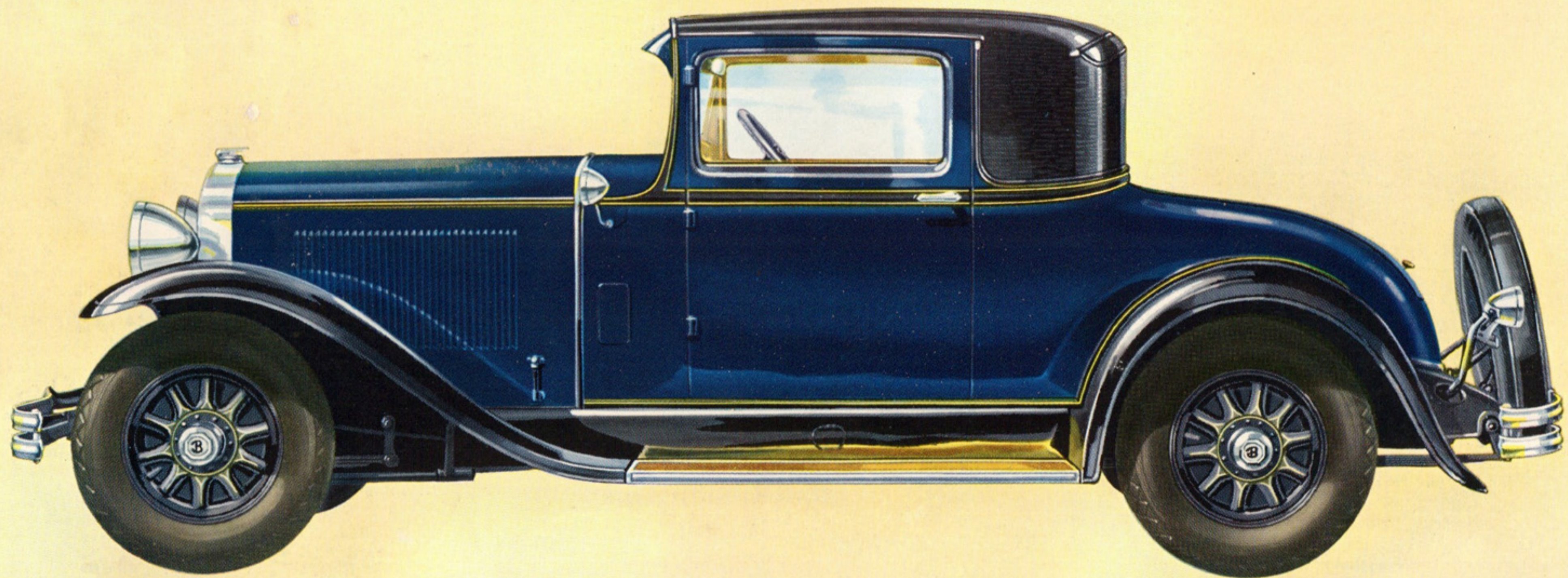

BUICK FOUR-PASSENGER SPECIAL COUPE

*Model 8-66S on 118-inch wheel base*

The special top material and decorative side hinges on this Buick combine with its smart lines and new colors to make it truly distinctive. The rear deck has a comfortable seat and is completely trimmed. The rear window lowers to permit conversation between passengers in the two compartments.

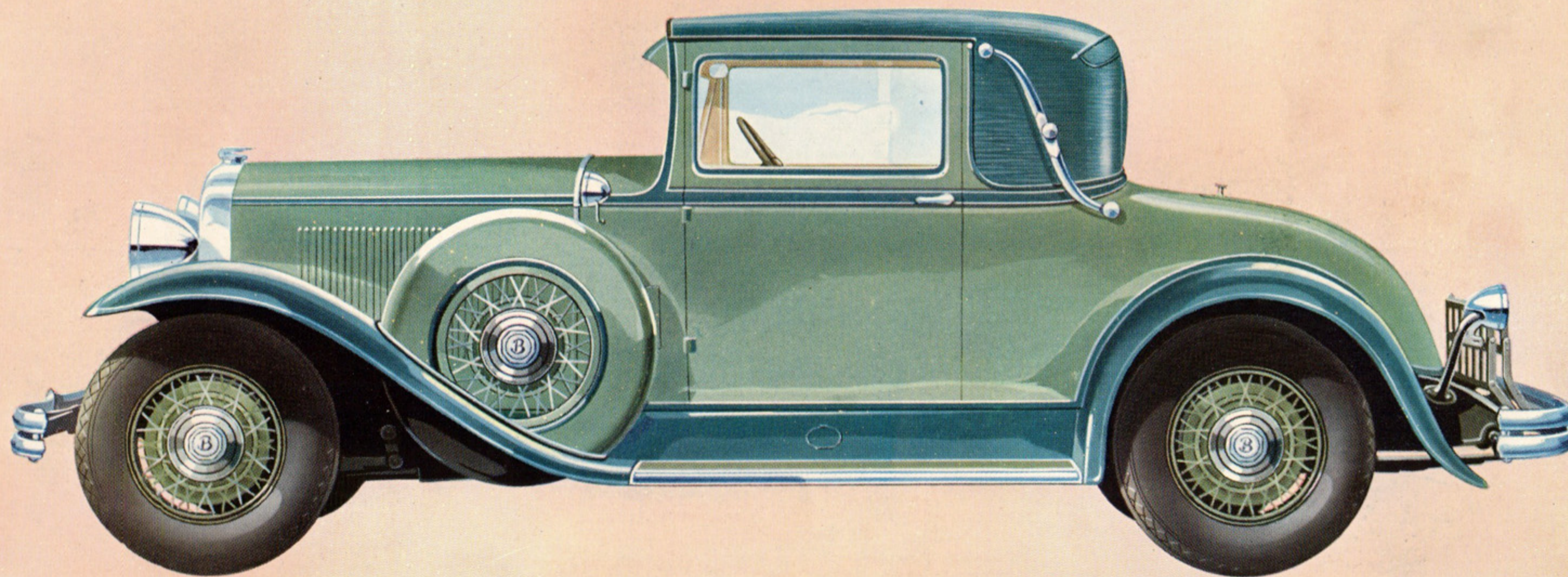



BUICK FIVE-PASSENGER FOUR-DOOR SEDAN

*Model 8-67 on 118-inch wheel base*

Powered by a 90-h.p. Buick Valve-in-Head engine, with a speed of 80 miles an hour, and equipped with the Buick Syncro-Mesh transmission, this Sedan is justly one of the most popular models in the Buick line. Beautiful, spacious, and comfortable, it meets the needs of the average family to perfection.

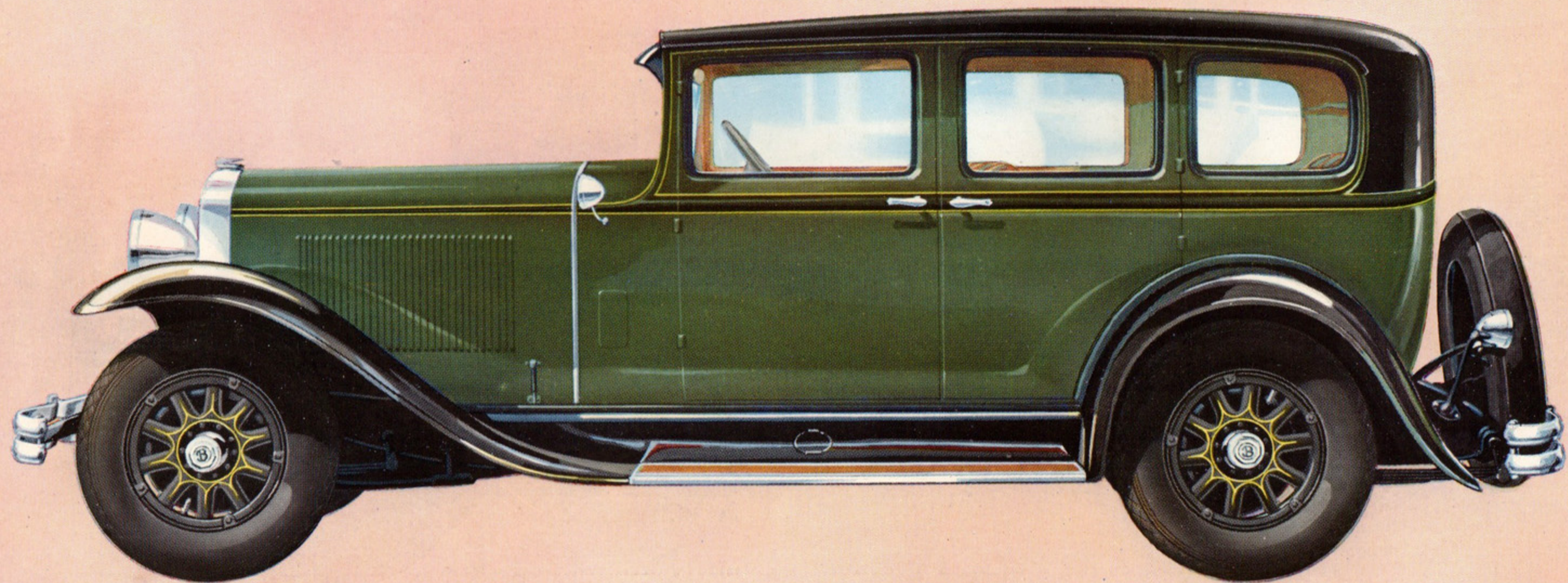

## MECHANICAL FEATURES OF THE 1931 VALVE-IN-HEAD STRAIGHT-EIGHT BUICKS

*A brief review of the fundamental factors that make the new Buicks—Series 8-90, 8-80, 8-60  
—so smooth, so powerful, so dependable*

**I**N addition to the fact that the Buicks for 1931 are powered by Valve-in-Head straight-eight engines, there are many other sensational mechanical developments of the greatest interest and significance to every motorist.

Foremost of these are the Buick Syncro-Mesh transmission in the Series 8-90, Series 8-80, and Series 8-60; and the Buick Oil-Temperature Regulator on all engines.

The engine itself, however, deserves first consideration. Built on the same basic principles that Buick has followed so successfully for twenty-seven years, it involves no unproved theories or untested principles. Its dependability and the correctness of its design have been so convincingly demonstrated in the service of more than 1,500,000 owners that they are beyond question.

Simplicity is still the keynote of its design. No other engine presents such a trim, clean appearance, and no other

engine is so accessible. The smoothness of performance, due to its eight-cylinder design, is increased by the heavy counter-balanced crankshaft with a new ring-type torsion balancer. The crankshaft is supported by five steel-back main bearings, stepped in size from front to rear, a rigid construction that is a still further help to smooth performance. Four-point suspension of the engine in vulcanized rubber mountings that absorb any slight vibration is another distinguishing feature. The cylinder block and the upper half of the crankcase are cast as a unit, making an important contribution to strength and rigidity.

The carburetion system is a dual type which assures an even flow of fuel to all cylinders and maximum operating efficiency. An intake silencer is combined with the air cleaner, eliminating noise at this point. The engine is also protected by an oil filter and a gasoline strainer and by ef-

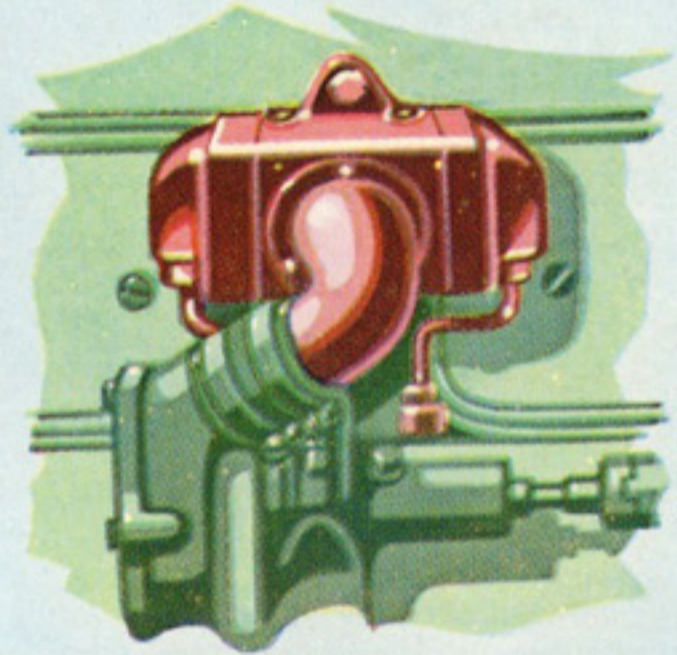

*Buick Oil-Temperature Regulator*

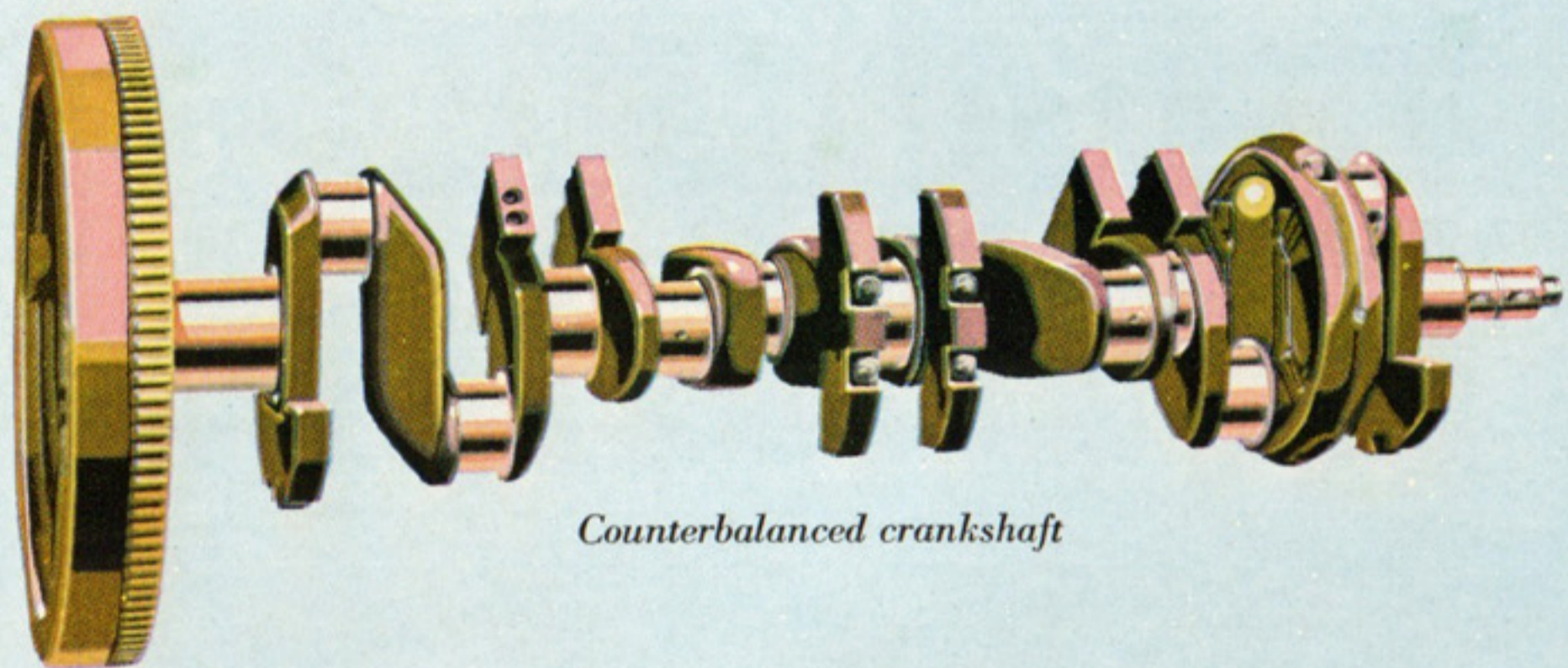

*Counterbalanced crankshaft*



*Ring-type torsional balancer*

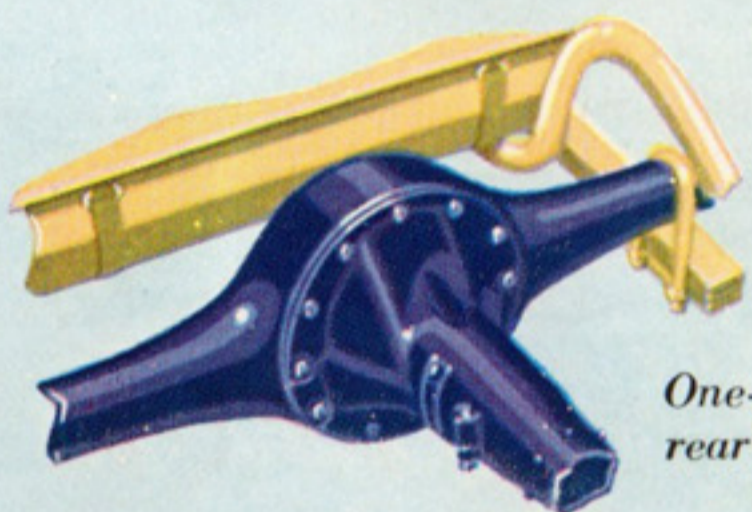

*One-piece, pressed steel rear axle housing*

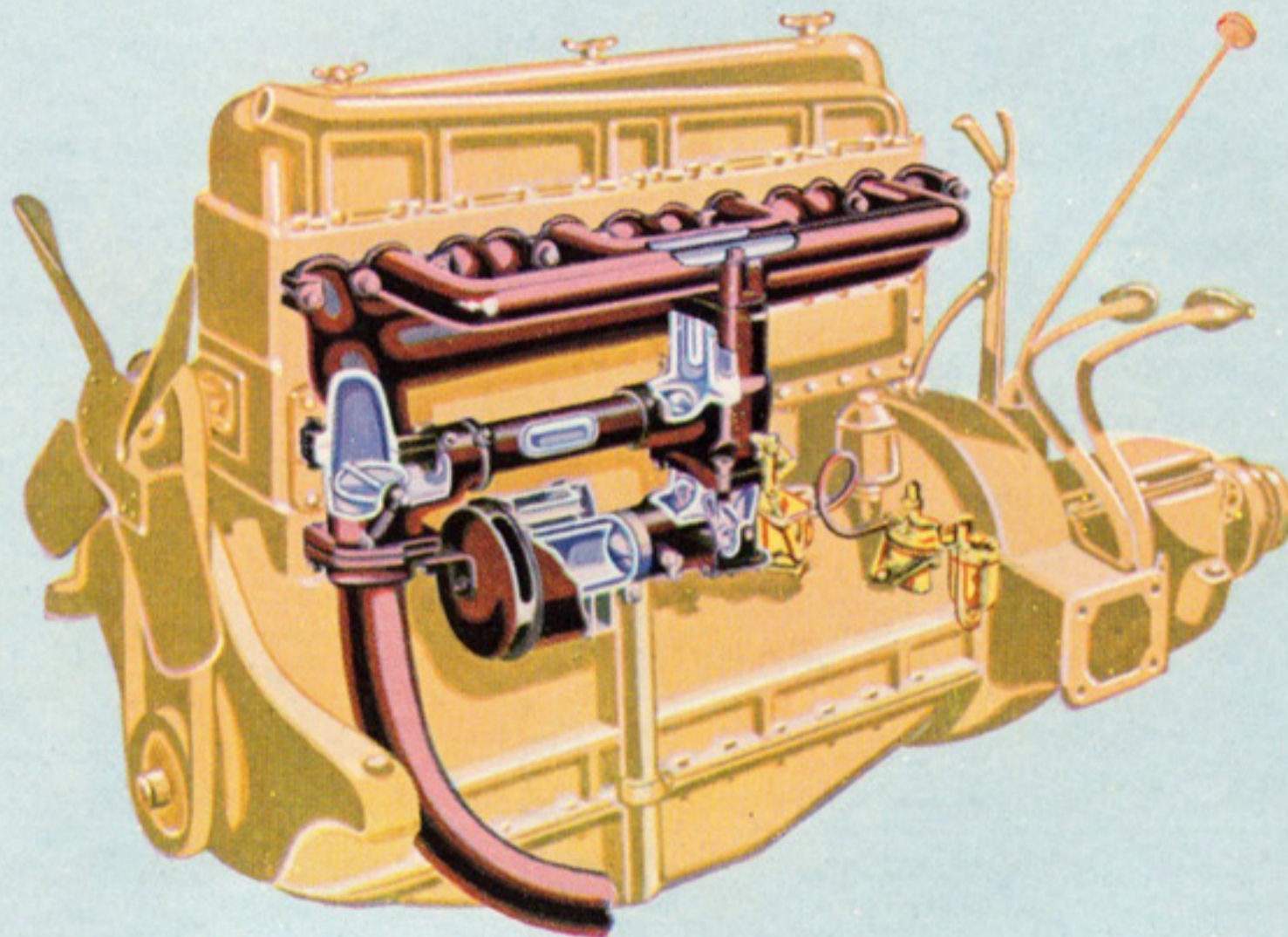

*Dual manifold and carburetor*

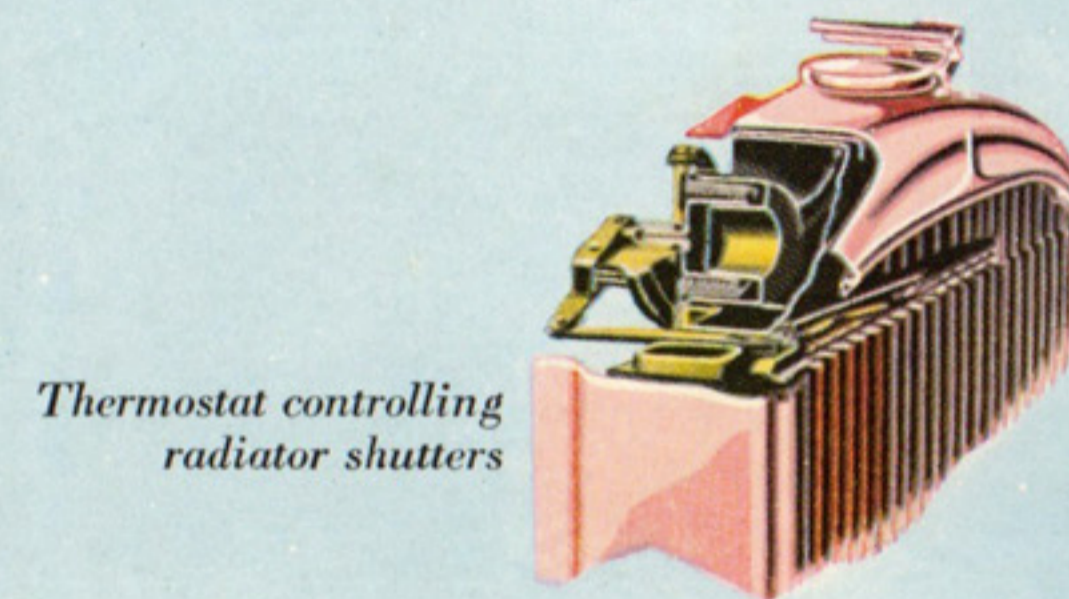

*Thermostat controlling radiator shutters*

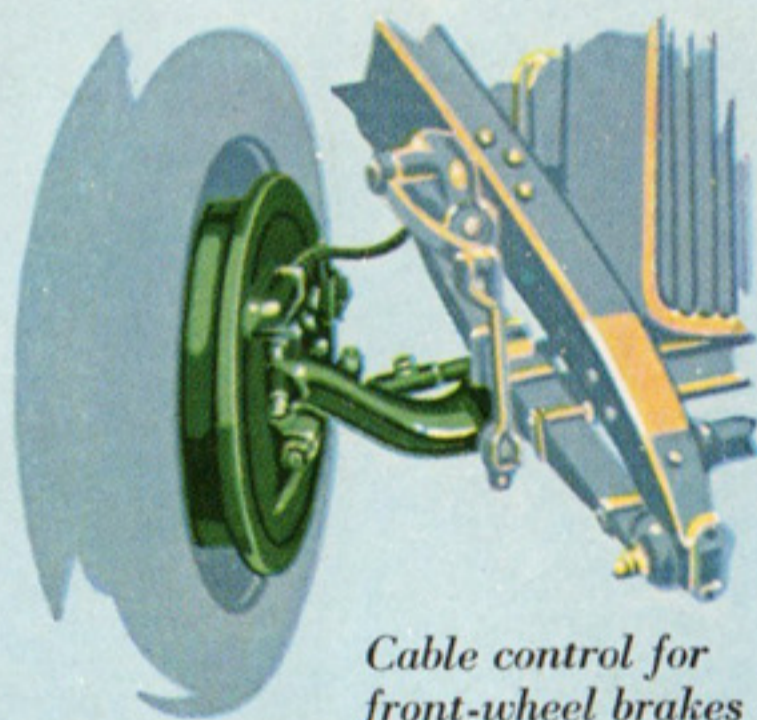

*Cable control for front-wheel brakes*

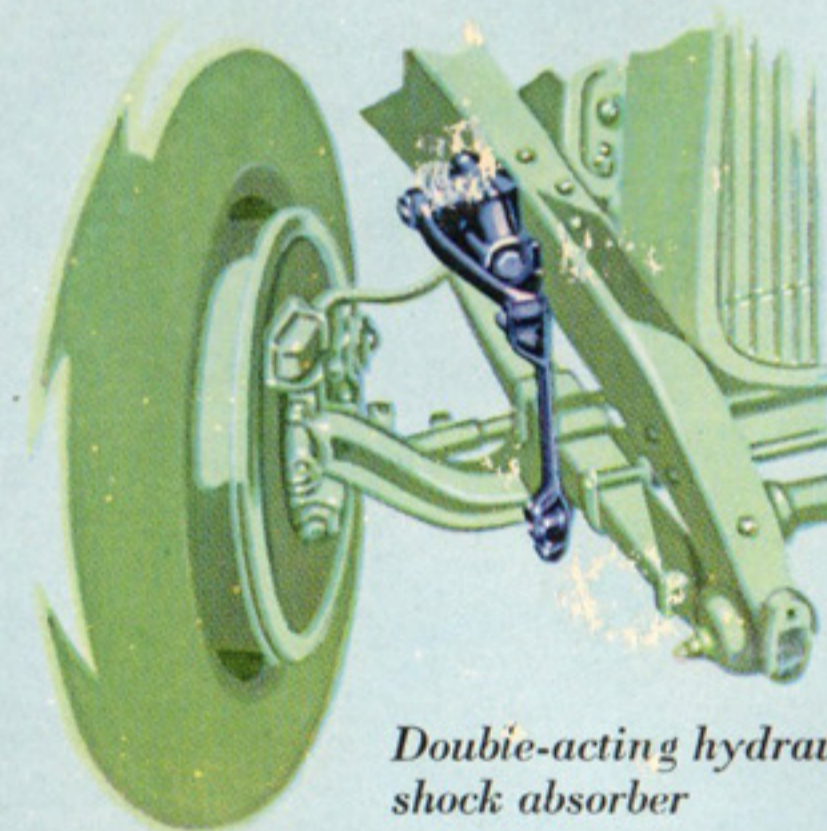

*Double-acting hydraulic shock absorber*

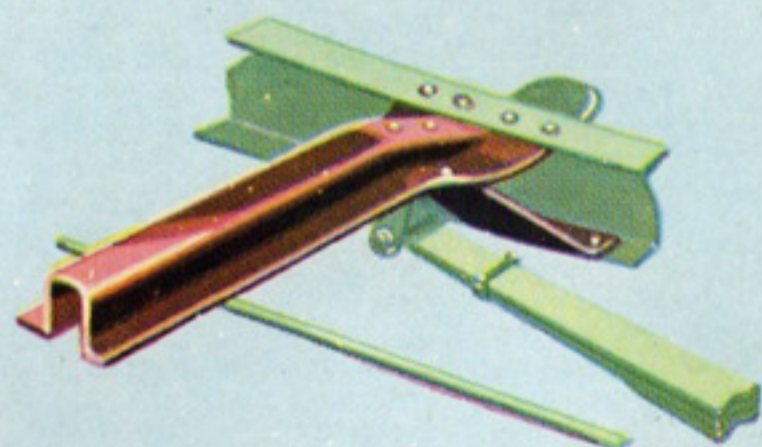

*New method of joining cross member to frame*

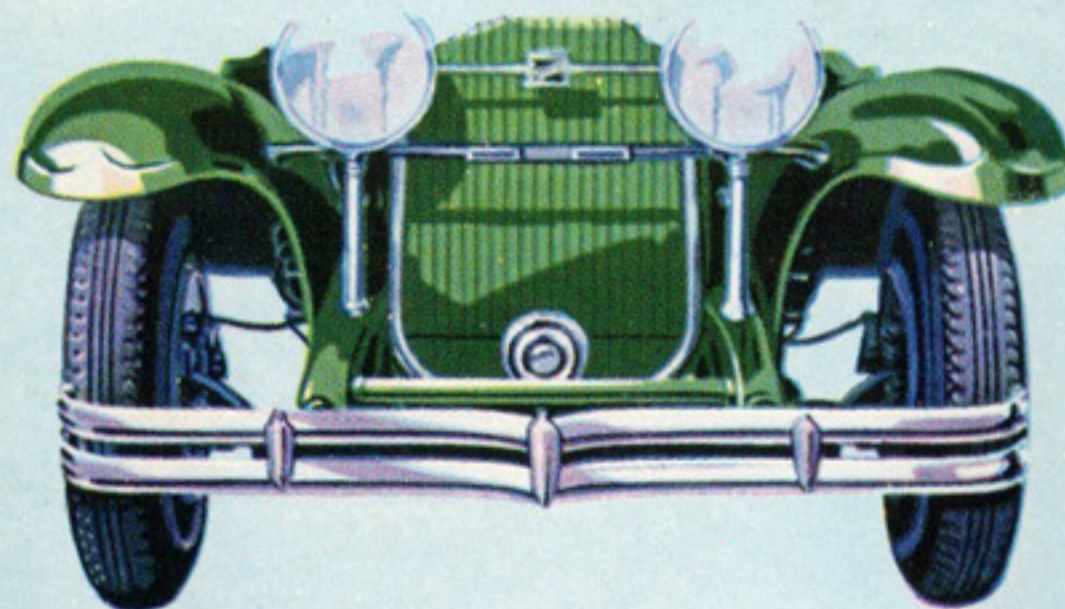

*Clean appearance under front wheels due to new cable control for front-wheel brakes*

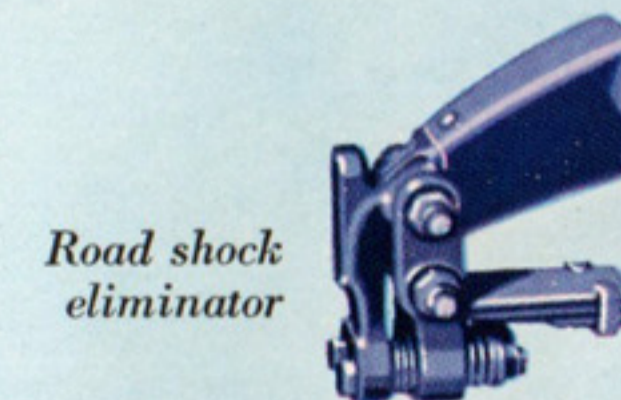

*Road shock eliminator*

fective ventilation of the crankcase. The crankshaft with its counterweights acts as a blower, forcing out of the crankcase fumes and vapor which might dilute the oil. Consequently, only four oil changes a year are necessary, with oil added from time to time as required.

The Buick Syncro-Mesh transmission, although very simple in design, is one of the most significant contributions to motoring satisfaction in many years. As the name implies, the gears in the transmission are automatically synchronized so that clashing is impossible when a shift is made. Need for a pause in neutral during a shift is eliminated. And, therefore, get-away is amazingly fast. In emergencies, such as in descending a steep hill, a shift from high to second gear can be made with the greatest ease.

Equally sensational is the Buick Oil-Temperature Regulator. The constant high speeds that are now possible in the Buick make control of the oil temperature just as essential as control of water temperature. Not only does the Regulator prevent overheating of the oil, but it also warms the oil quickly in cold weather, thus assuring efficient engine performance immediately after starting the motor.

Other important developments will be noticed through-

out the chassis. The frame is stronger, a new box-type cross member being used in the center, and the other cross members being stronger and connected to the frame in a new, rigid manner. Double-acting, hydraulic shock absorbers are mounted in new positions, eliminating sidesway. Cable control is used for the front-wheel brakes and the whole brake hook-up is simplified, making for more efficient operation and cleaner appearance of the chassis. The Buick torque tube drive and three-quarter floating-type rear axle with new one-piece, pressed steel housing are other important features that typify Buick sturdiness.

The torque tube on the Series 8-90, 8-80, and 8-60 completely encloses the propeller shaft, protecting it from dirt and water. It also holds the shaft in strict alignment with the rear axle so that full driving force is exerted at all times.

The three-quarter floating-type rear axle on the Series 8-90, 8-80, and 8-60 permits the full weight of the car to be borne on the rear axle housing, leaving the axle free to drive wheels. The springs are also relieved of driving strain and, therefore, are very flexible and easy riding.

In this, as well as other features, the new Buicks are far ahead of any cars in their class.

A BUICK VALVE-IN-HEAD STRAIGHT EIGHT

*within reach of almost every motorist*

---

BUICK SERIES 8-50 ON 114-INCH WHEEL BASE

---

**P**RICED lower than any other Valve-in-Head Straight Eight in the world, and comprising six attractive models, the Buick Series 8-50 will be hailed by thousands who have long looked forward to Buick ownership. Here are a Four-Door Sedan, Two-Door Sedan, Sport Roadster, Phaeton, Business Coupe, and Special Coupe, all powered by Buick Valve-in-Head Straight-Eight engines, and all offered at remarkably low prices.

Built on a long wheel base of 114 inches, with large, roomy bodies by Fisher, they bring all the advantages of fine car ownership to the motorist who is seeking the utmost value for his dollar.

## THE BUICK SERIES 8-50 VALVE-IN-HEAD STRAIGHT EIGHT

*Large, sturdy cars that hold the road well at high speeds and afford maximum comfort and satisfaction*

**B**UICK through and through, the Series 8-50 models of the complete Buick line for 1931 open up Buick ownership to thousands of motorists who have always wanted to drive a Buick. And such a wide choice of models is offered within the series that every motoring need can be satisfied.

One of the most attractive models is the Two-Door Five-Passenger Sedan. In addition there is a Four-Door Sedan, Two-Passenger Business Coupe, Four-Passenger Special Coupe, Sport Roadster, and a Phaeton. Each model has features that will appeal particularly to certain groups of owners, but all are alike in that they are powered by a Buick Valve-in-Head Straight-Eight engine.

To drive one of these new cars is a thrilling experience. Never before has such smooth, instant power been at the command of the driver. Getting away like a flash, the car sweeps up to high speed almost in an instant. And when a

still faster pace is demanded it responds like magic until a steady speed of 75 miles an hour is reached.

So sturdily are the cars built, however, that even at the highest speeds there is no sense of strain or effort such as often attends fast driving in other cars. Being large cars, they hold the road well and handle easily at all speeds. And because of their roominess they afford greater motoring comfort than can ever be attained in cars of smaller wheel base.

Like all the Buicks, the Series 8-50 models are remarkably free from noise at all speeds. This is due to the naturally quiet operation of the Buick engine, the strengthening of the body, and complete insulation of front compartments by means of sound-absorbing material on the dash and insulated mats on the floor.

The motoring world offers no other values, outside the Buick line, that can compare with these Series 8-50 Buick Valve-in-Head Straight Eights.

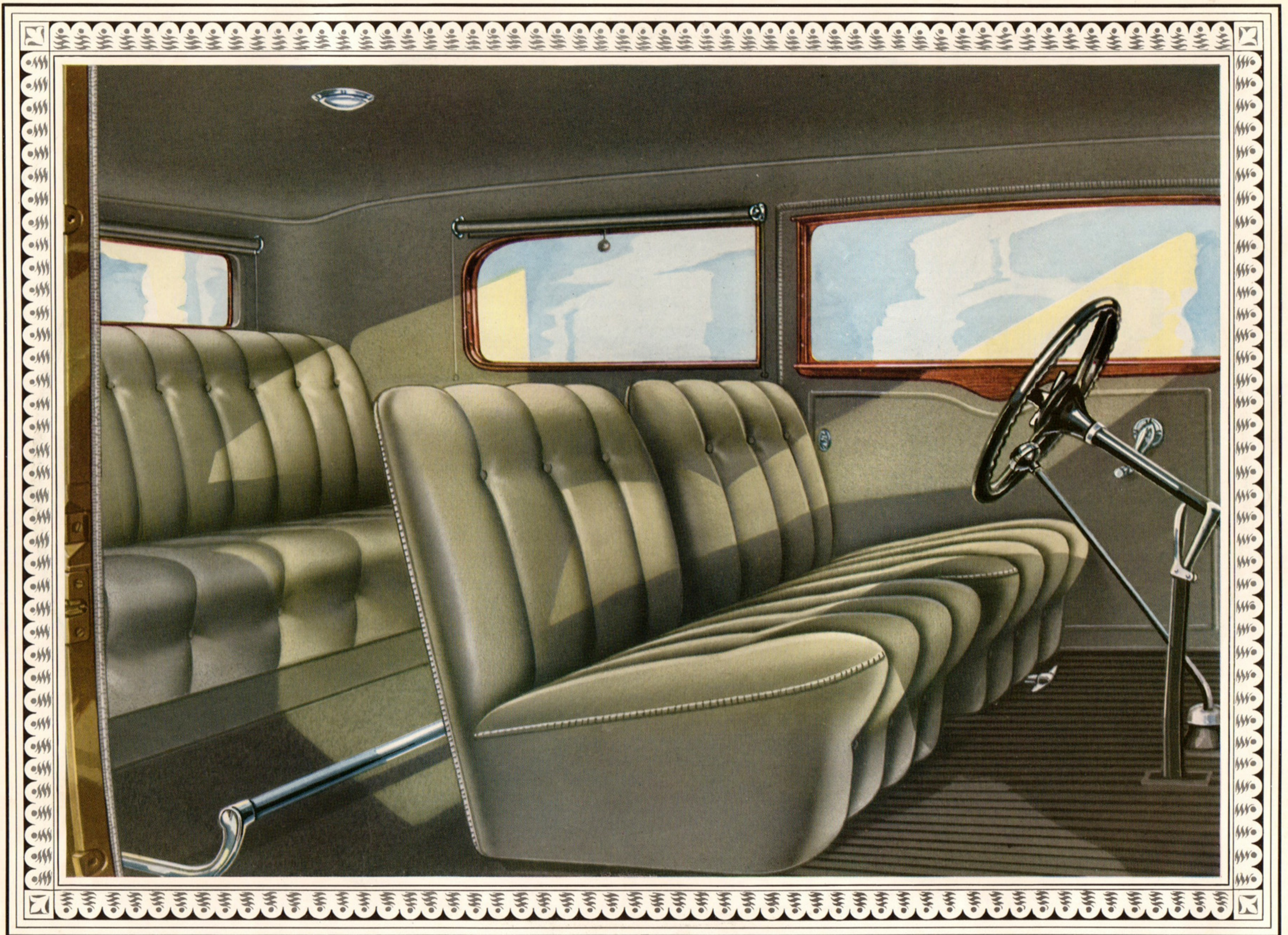

## LARGE CARS FOR COMFORT—BUICK SERIES 8-50

**N**OT since the days of four-cylinder cars have Buicks been offered at such low prices as the attractive models in the Buick Series 8-50. Motorists who have looked forward to Buick ownership can now drive not only a Buick but a Buick Valve-in-Head Straight Eight.

In doing so they will enjoy Buick's smooth power and speed and Buick's dependable mechanical construction. But, in addition, they will also enjoy the extra comfort and convenience due to the ample size of these Buicks. For the cars in the Buick Series 8-50 are large cars—by far the largest on the market at anywhere near the same price.

This is apparent the moment one examines the interiors. Just a glance is sufficient to show the generous amount of leg room in both the driving compartment and the rear compartment. And although the cars are smartly low in appearance, head room, too, is unusually ample. The wide, comfortable seats are low and deep, built up over special soft springs, and carefully tailored to shape so that they are truly restful even on the longest drives.

They are upholstered in colorful mohair plushes or in

special cloth of pleasing design. The open models are upholstered with genuine leather. Other features of the interiors are of the same high quality. The hardware is of special Buick design, very attractive in appearance. The steering wheel and instrument panel are new in design, and other pleasing features are the velvet carpets in rear compartments, silk-finish window curtains, mahogany garnish moldings, dome lights in closed models, arm rests on rear seats, foot rests, aluminum scuff plates on doorsills, and rubber-cushioned door stops.

The front compartments are fully protected against drafts by means of thickly insulated rubber floor mats and special insulation on the dash. This also completely shuts out sound so that the cars are remarkably quiet—a genuine contribution to motoring satisfaction.

The accelerator is the new, rubber-covered treadle type. Driving seats are adjustable. The windshields are the Fisher VV type, nonglare. In short, all the important features that make the Buick so desirable are included in these spacious, low-priced cars.



BUICK FIVE-PASSENGER TWO-DOOR SEDAN

*Model 8-50 on 114-inch wheel base*

Its remarkably low price makes this roomy Sedan very desirable. The doors are wide and the individual front seats fold forward so that it is very easy for passengers to enter or leave the car. The upholstery is mohair or cloth. Tools are carried in a convenient compartment under the front seat.

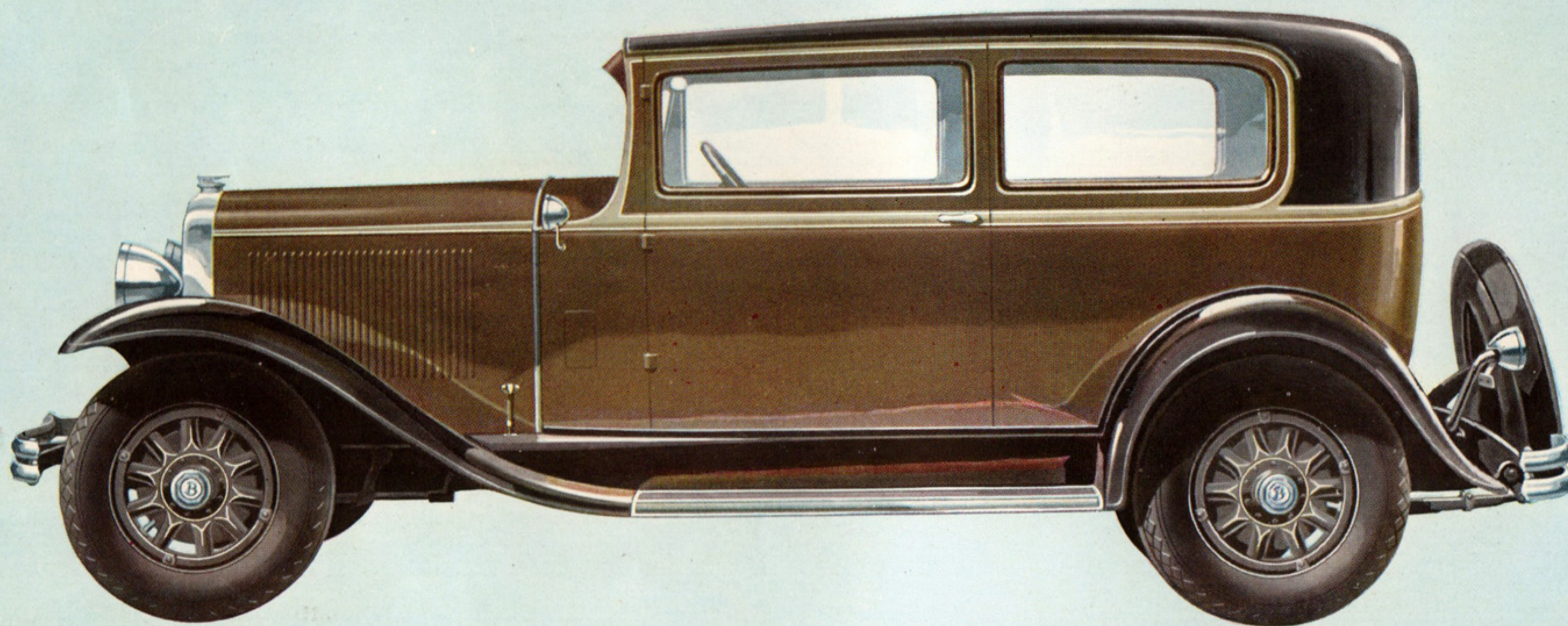

**BUICK FOUR-PASSENGER SPORT ROADSTER**

*Model 8-54 on 114-inch wheel base*

The smart appearance of this Roadster with its low top is matched by its smooth speed and easy handling. It is finished in genuine leather and has a wealth of nickel and chromium trimming. The windshield can be folded forward when the top is down, accenting the racy appearance and permitting full enjoyment of the breeze.

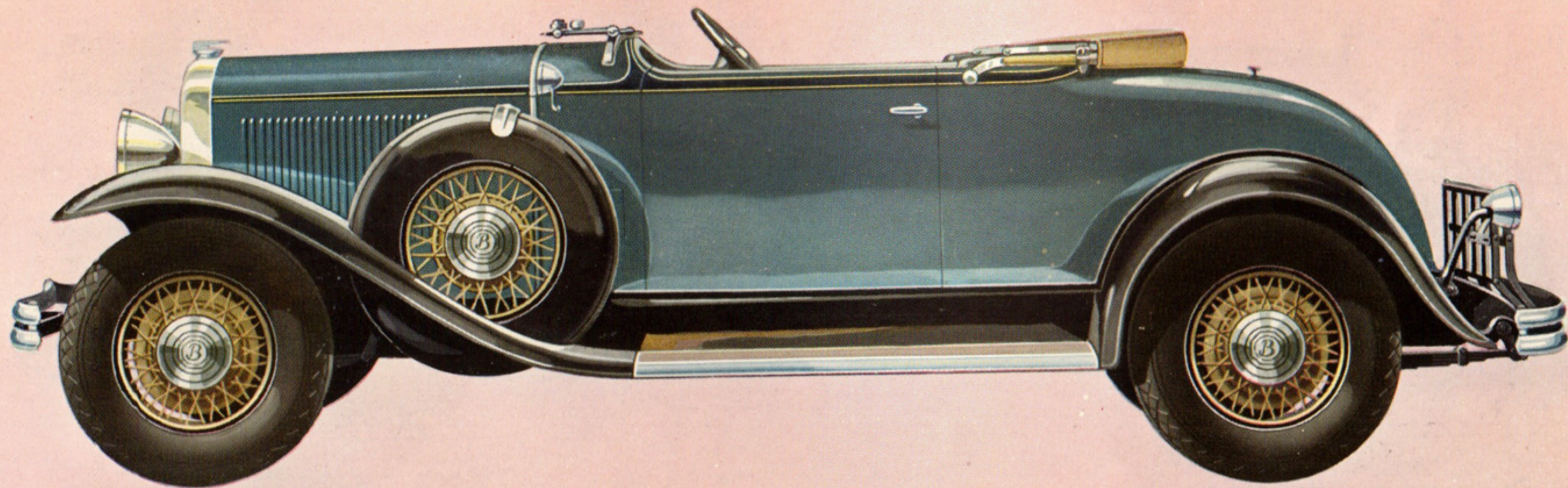

## BUICK FIVE-PASSENGER PHAETON

*Model 8-55 on 114-inch wheel base*

The leather-upholstered seats in this sport model, as in all the Buicks, are low and comfortable. The rear seat has arm rests. Interior appointments include a carpet in the rear compartment, foot rest, robe strap, and large pockets in all doors. The smartly shaped top folds compactly into a boot.

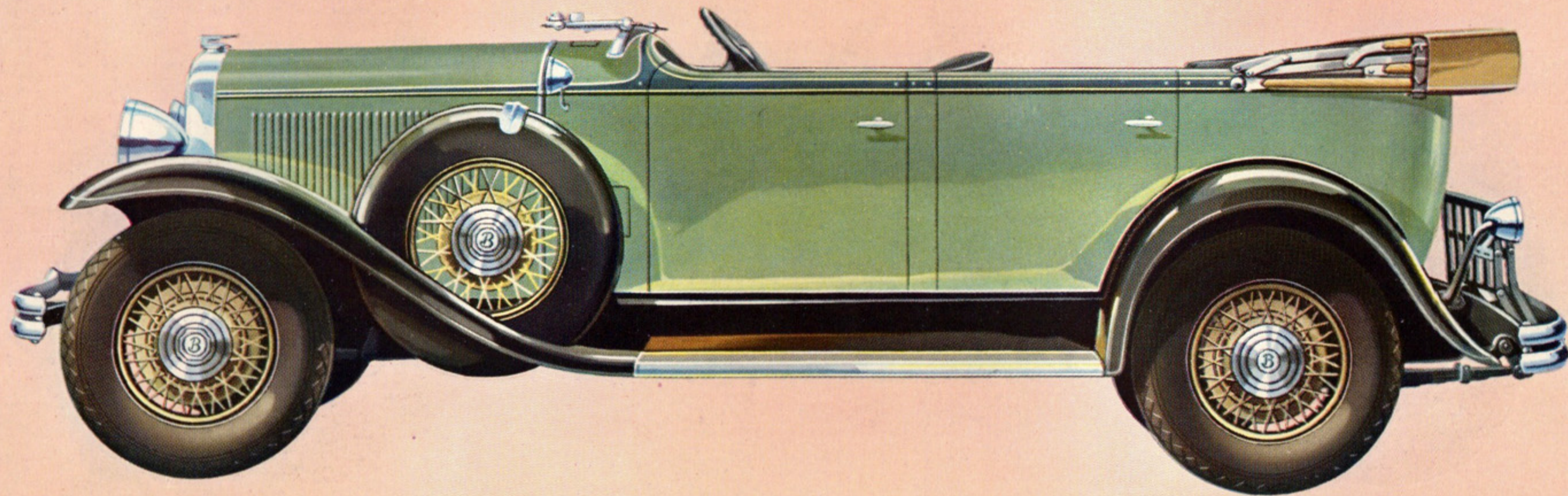

BUICK TWO-PASSENGER BUSINESS COUPE

*Model 8-56 on 114-inch wheel base*

Because of its large size, its sturdiness, and its power and speed, this Buick Valve-in-Head Straight Eight is well suited to business use as well as general purposes. The spacious rear deck with wide door and a compartment behind the driving seat provide convenient spaces for carrying luggage and other articles.

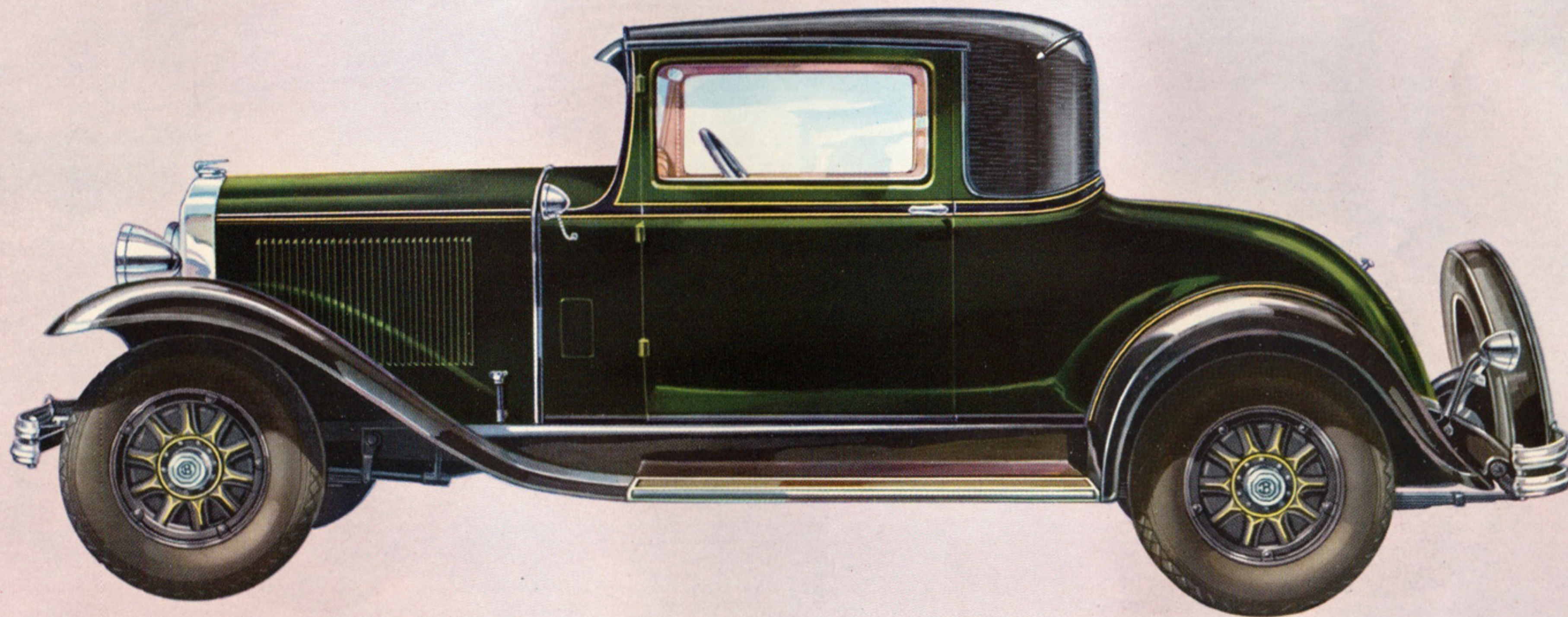

BUICK FOUR-PASSENGER SPECIAL COUPE

*Model 8-56S on 114-inch wheel base*

Impressive in size and powered by a 77-h.p. Buick Valve-in-Head Straight-Eight engine, capable of speeds of 75 miles an hour, this Special Coupe is decidedly attractive. Special top material adds to its smart appearance. The comfortable deck accommodates two passengers.

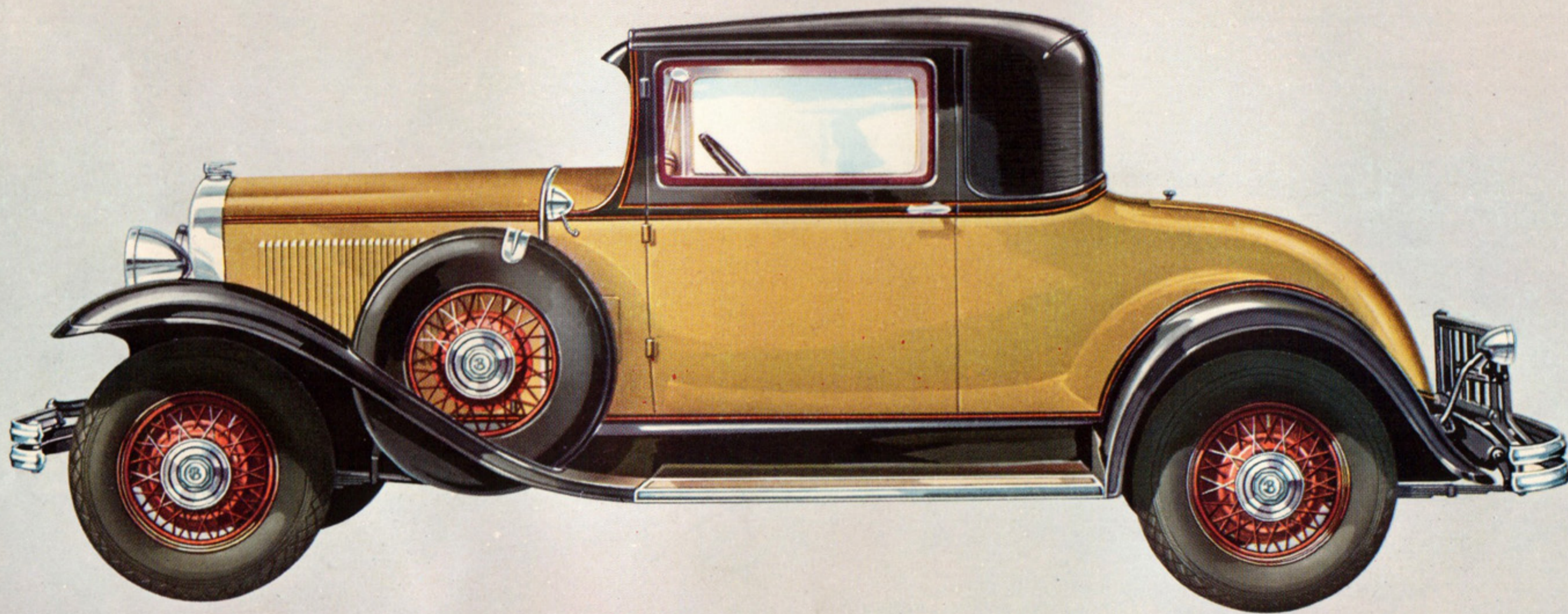

BUICK FIVE-PASSENGER FOUR-DOOR SEDAN

*Model 8-57 on 114-inch wheel base*

The pleasing interior of this spacious model is in keeping with its smart exterior appearance and its dependable performance. The upholstery is button style in mohair plush or cloth. The car has complete appointments such as arm rests, foot rest, rear compartment carpet, assist cords, dome light, and screened cowl ventilators.

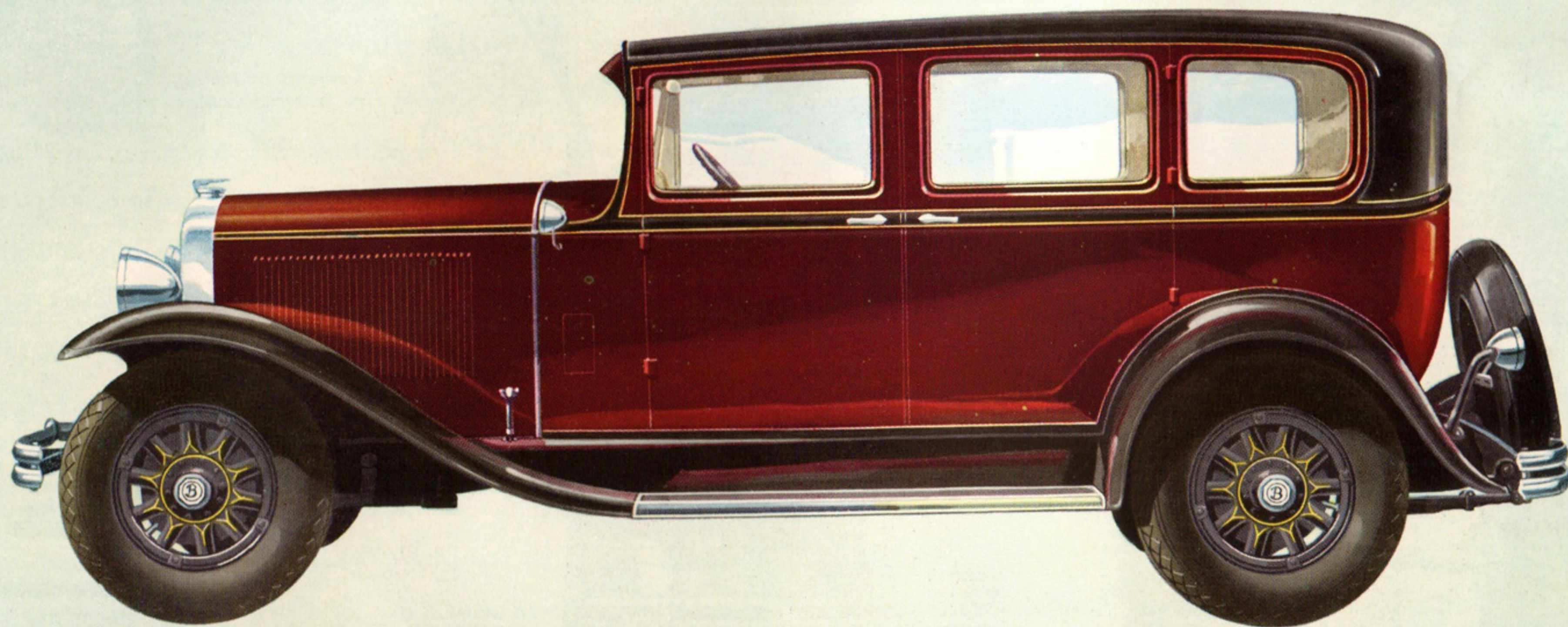

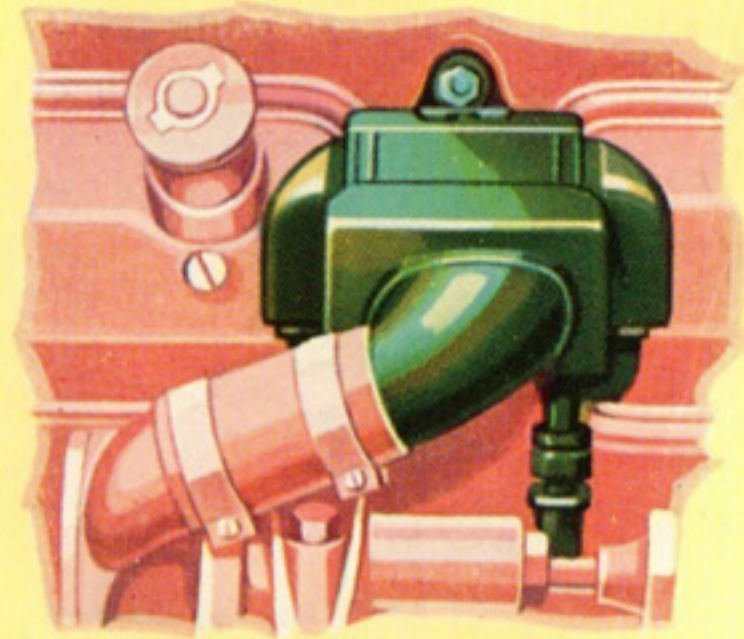

*Buick Oil-Temperature Regulator*

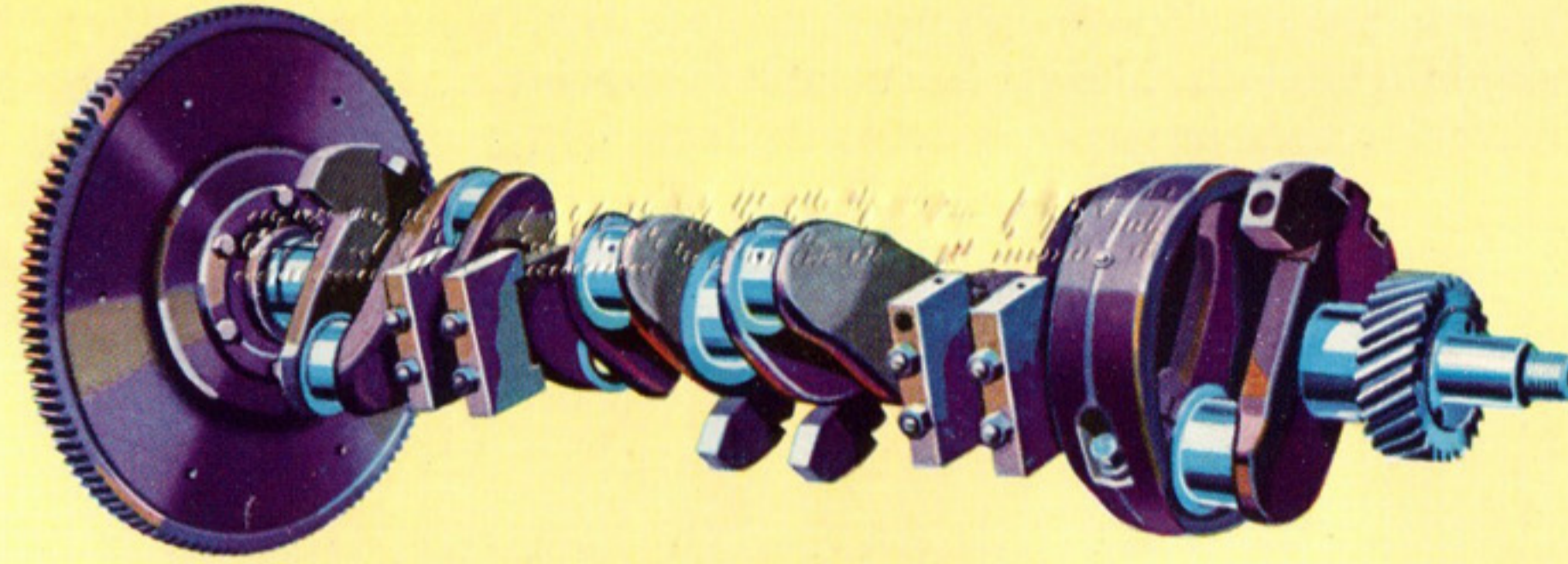

*Counterbalanced crankshaft and ring-type torsion balancer*

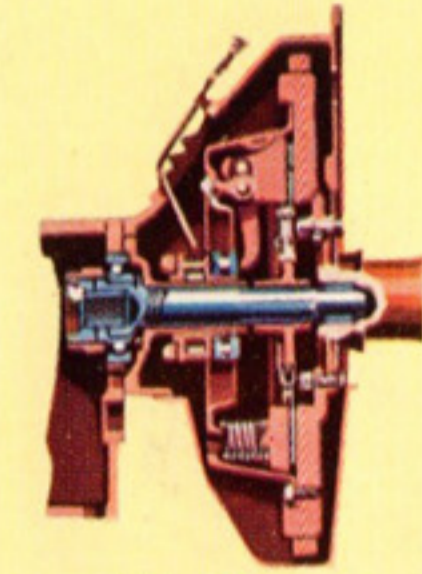

*Clutch*

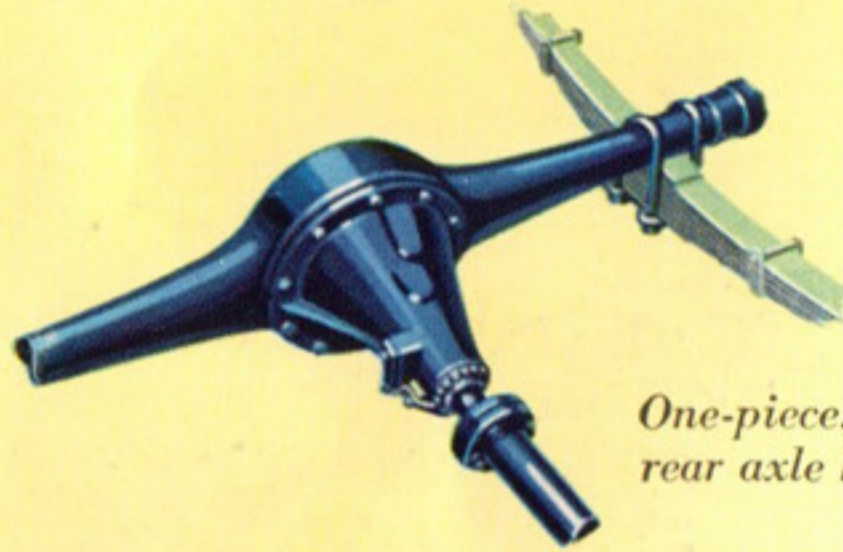

*One-piece, pressed steel rear axle housing*

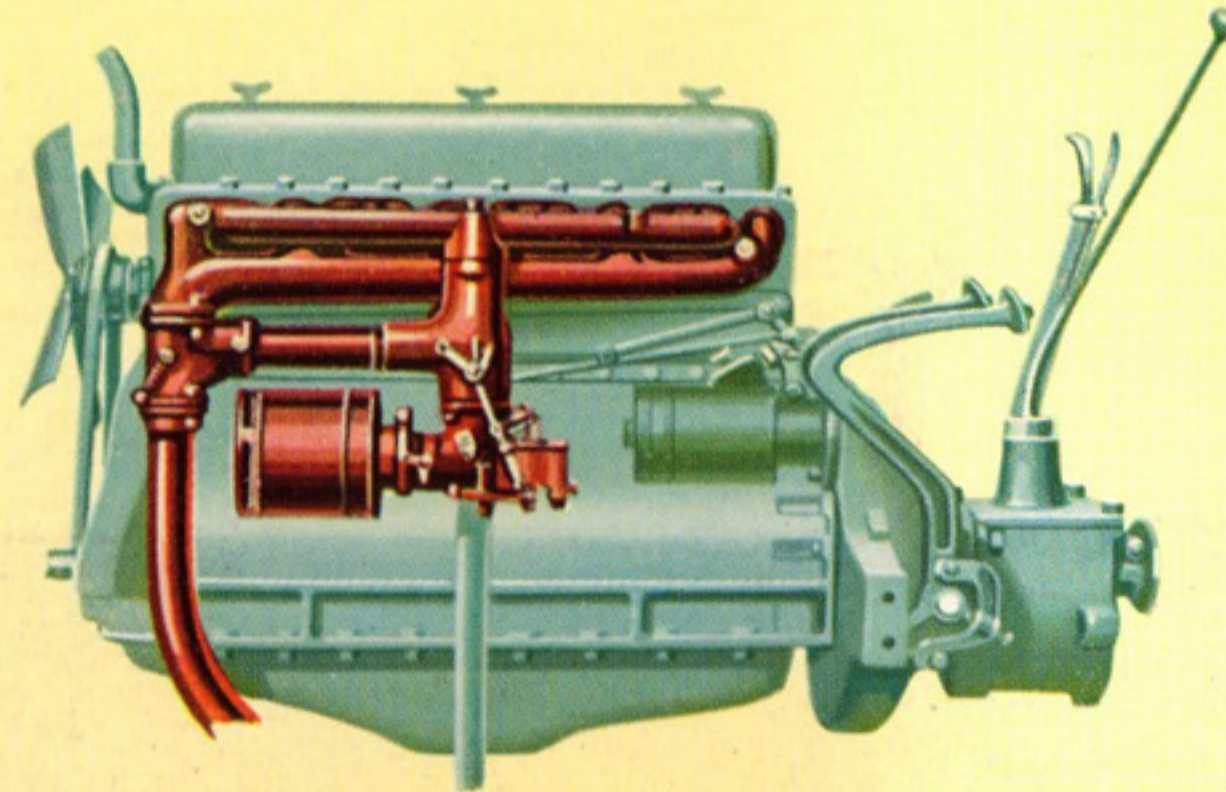

*Manifolding of the Buick Valve-in-Head Straight-Eight engine — Series 8-50*

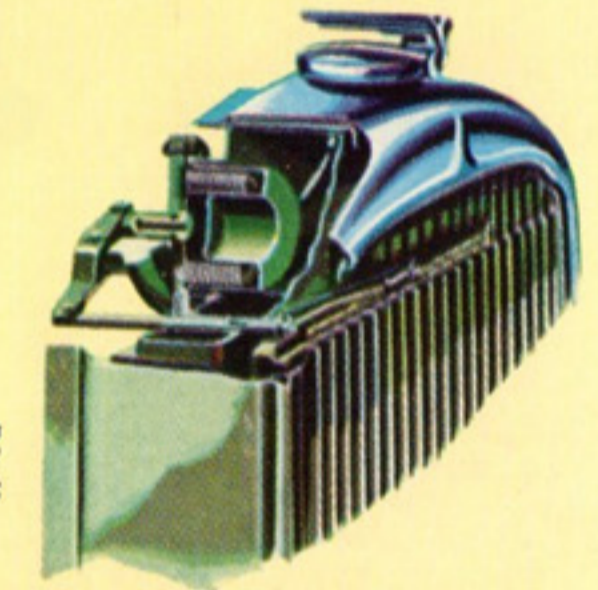

*Thermostat controlling radiator shutters*

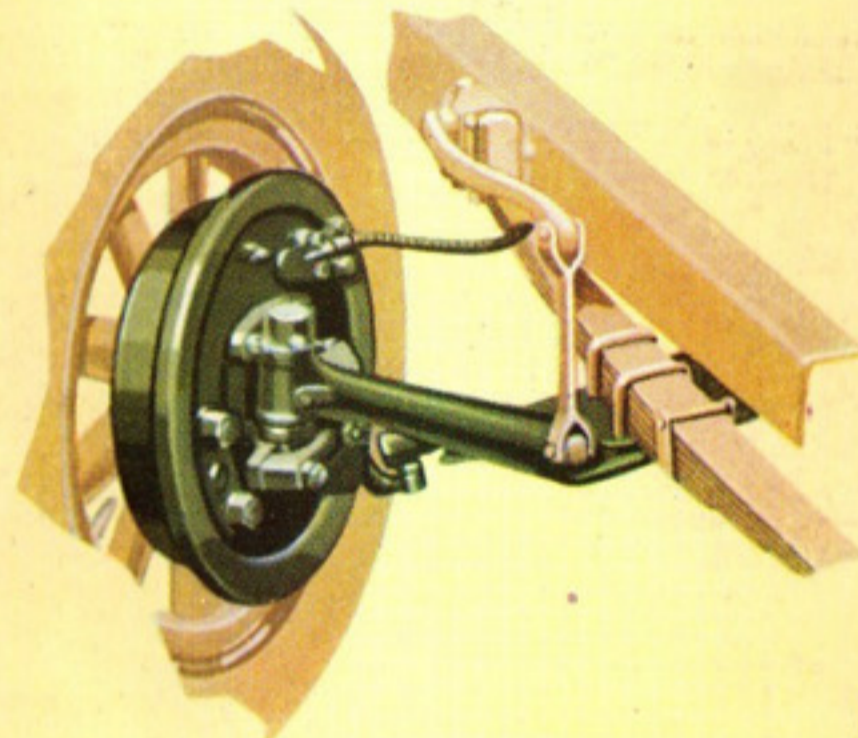

*Front-wheel brake cable*

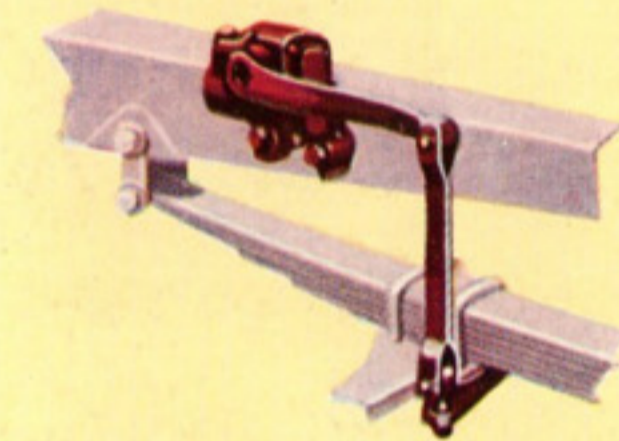

*Front hydraulic shock absorber*

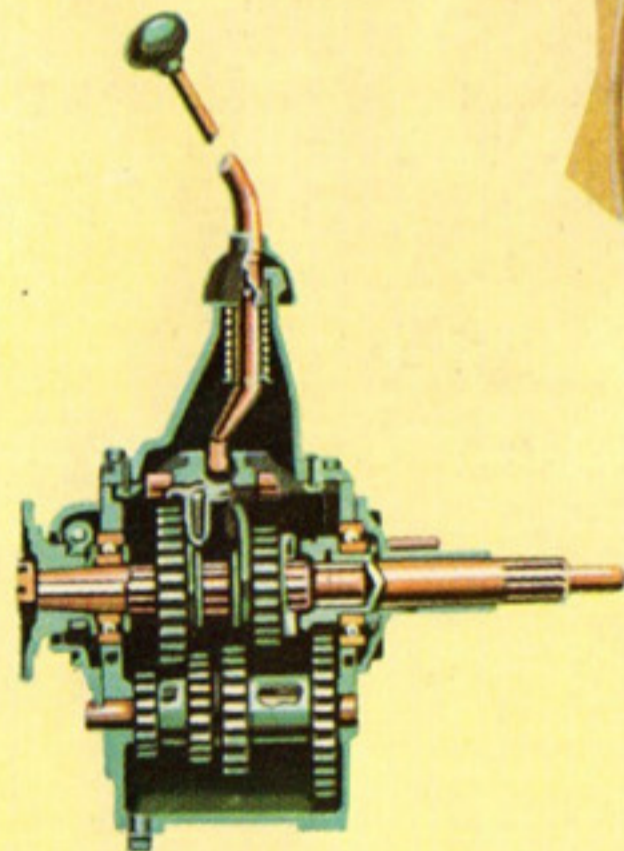

*Transmission Series 8-50*

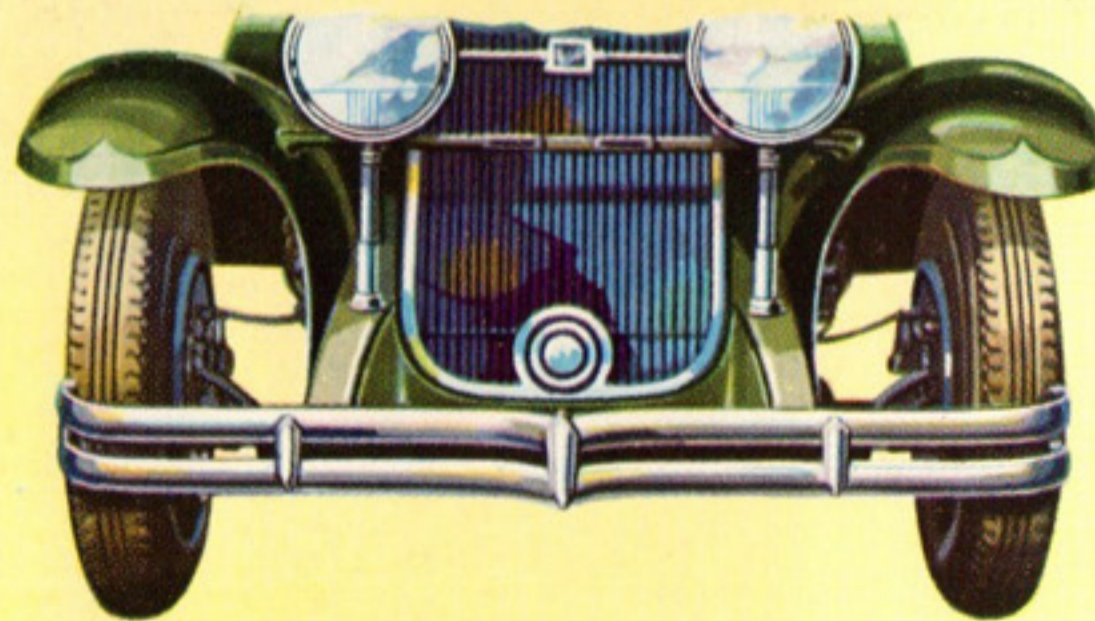

*Front view showing clean appearance due to simplified braking system*

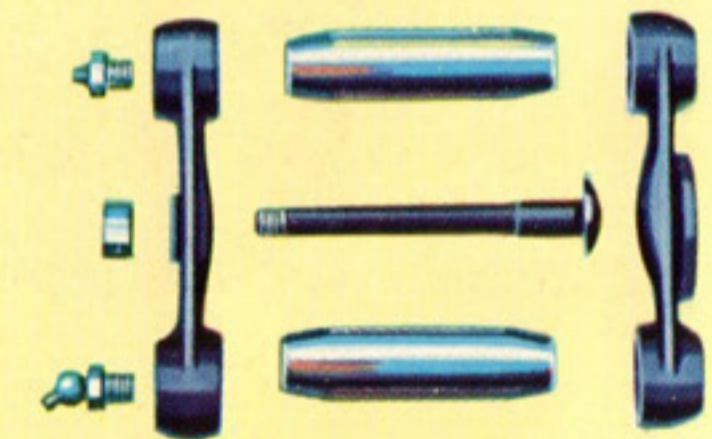

*Self-adjusting spring shackle*

## MECHANICAL DEVELOPMENTS OF THE SERIES 8-50 BUICK

**T**HE engine of the Buick Series 8-50 models, like that of all the other 1931 Buicks, is a Valve-in-Head Straight Eight. Its fundamental principles of construction are the same ones that Buick has followed so successfully for twenty-seven years. It combines the extra power, due to the Valve-in-Head principle, with the smoothness that results from straight-eight design.

Developing 77 horsepower, it drives the cars at a speed of 75 miles an hour with a smoothness that brings a new delight to motoring. Its stamina is equally remarkable. It meets the challenge of the steepest hill and it accelerates in high gear with the greatest ease so that a very minimum of gear shifting is required.

The heavy crankshaft is counterbalanced and equipped with a ring-type torsion balancer, assuring a velvety, even flow of power. It is supported by five steel-back main bearings, which hold it very rigidly. The cylinder block and the upper half of the crankcase are cast as a unit. The suspension is the four-point type with mountings insulated by vulcanized rubber to absorb vibration.

Foremost of many features is the Buick Oil-Temperature Regulator. This is a simple device with no working parts and requiring no attention from the owner. Water from the cooling system circulates through the Regulator, cooling the outside walls of the passages through which the oil flows. This keeps the oil from overheating and losing its lubricating quality. Because of the protection thus afforded, the new Buicks may be driven at high speed just as long as road conditions permit. The Regulator has further value in that it warms the oil in cold weather immediately upon starting the engine. The Buick is the only car with this double protection.

Efficient lubrication is still further assured by an oil filter and by ventilation of the crankcase. The counterweights on the crankshaft act as a blower, forcing fumes and vapors out of the crankcase through a special outlet that carries them entirely clear of the car. They have no chance to condense and dilute the oil in the crankcase. Only four oil changes a year are necessary, with oil added as required between changes.



The cooling system is equally efficient. The radiator is equipped with shutters which open and close automatically under the control of a thermostat. They are specially mounted so that road shocks will not cause them to warp and bind. The radiator itself is very rigidly mounted to the frame in a manner that prevents road shocks from reaching the core.

All units of the chassis are designed to permit full enjoyment of the power furnished by the engine. The transmission and clutch are very easy in operation and unusually sturdy in construction. The frame, too, is exceptionally rigid, and is well braced with heavy cross members. The rear axle housing is the oiltight, one-piece, pressed-steel type, noted for its strength.

Hydraulic shock absorbers are mounted directly beneath the frame cross members. In this position strains and deflections are reduced to a minimum. Riding ease is further increased by semi-elliptic overslung front springs and semi-elliptic underslung rear springs, with long, wide spring leaves. The spring shackles are the self-lubricating and self-adjusting type.

Buick Duo-Servo internal four-wheel brakes are used

on all models, with cable control for the front brakes. The cables are enclosed in a dirt-proof housing so that they need no attention or adjustment. They greatly improve the appearance of the car from the front. Other parts of the brake hook-up have also been simplified, reducing the number of cross shafts and rods and making for greater efficiency and neatness.

The emergency or parking brake is also the four-wheel type using the same braking surface as the service brakes.

The steering gear is the worm-and-sector type. It is very strong and affords easy control of the car at every speed.

Every other unit of the chassis is marked by the same sturdiness and dependability. And every working part is designed not only to operate smoothly from the beginning, but to continue giving satisfactory service for far longer than in most cars.

This is a fact that should be given thoughtful consideration, for it represents the truest kind of motoring economy. The Buick, because of its longer life and freedom from heavy upkeep expense, really costs less, in the long run, than cars of lower price.

## BODIES BY FISHER FOR THE 1931 BUICK VALVE-IN-HEAD STRAIGHT EIGHTS

**T**HE sturdiness for which the Buick chassis is noted is also a fundamental characteristic of the bodies by Fisher, which are used on all the 1931 Buick models. Even while the new Buick models existed only in engineering blue prints, body experts from the Fisher Body Corporation were called into consultation and worked with Buick engineers from the start in designing the new cars. Consequently, chassis and body in the new Buick are a unit, affording riding ease that can be attained in no other way.

Just as all the units of the chassis have been strengthened in line with the extra power of the Buick Valve-in-Head Straight-Eight engine, so, too, has the body been developed to meet the demands of constant driving at high speeds. Strength has been added at point after point, new methods of bracing have been developed, weaknesses have been ruthlessly searched out by thousands of miles of driving over all kinds of roads. As a result the Buick bodies are pleasantly free from noise and rumbles, and have unusual durability.

The stringency of the tests to which the bodies were submitted may be judged from the fact that much of the test driving was done over specially built Belgian block roads. These are noted for their roughness, and few owners are likely to encounter anything equaling them. But the Buick Fisher bodies stood up under this test—the hardest punishment that could be devised for them.

Such strength and such durability are not the result of some one or two simple features of design. Instead they require painstaking study of hundreds of details.

For instance, the entire framework of all closed bodies has been greatly strengthened by using metal brackets in place of glued joints to connect the top to the frame. Stronger brackets are used at the windshield posts and at the rear corners. The front corners, too, have a new brace, and a metal header bar is another new source of strength. The door posts are strengthened by a new brace and many other points also have been given extra support.

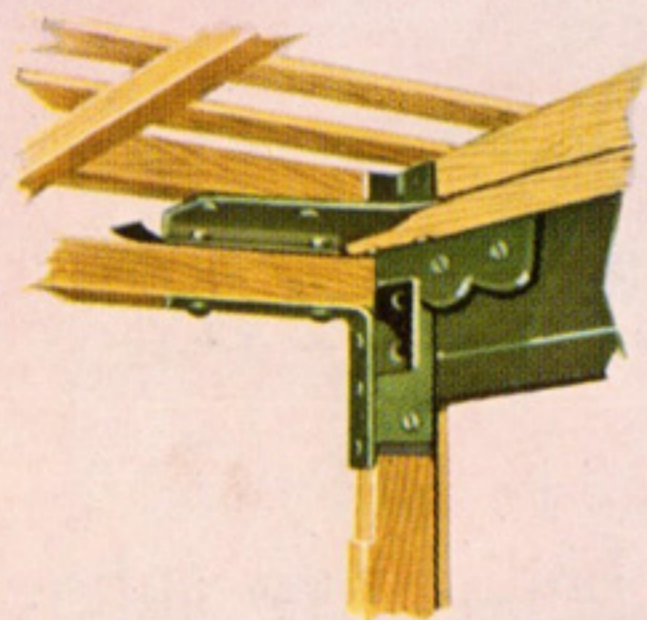

Front corner brace

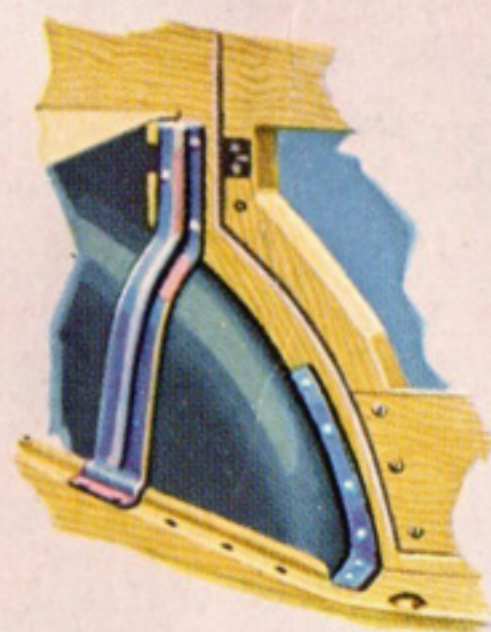

Rear hinge post brace

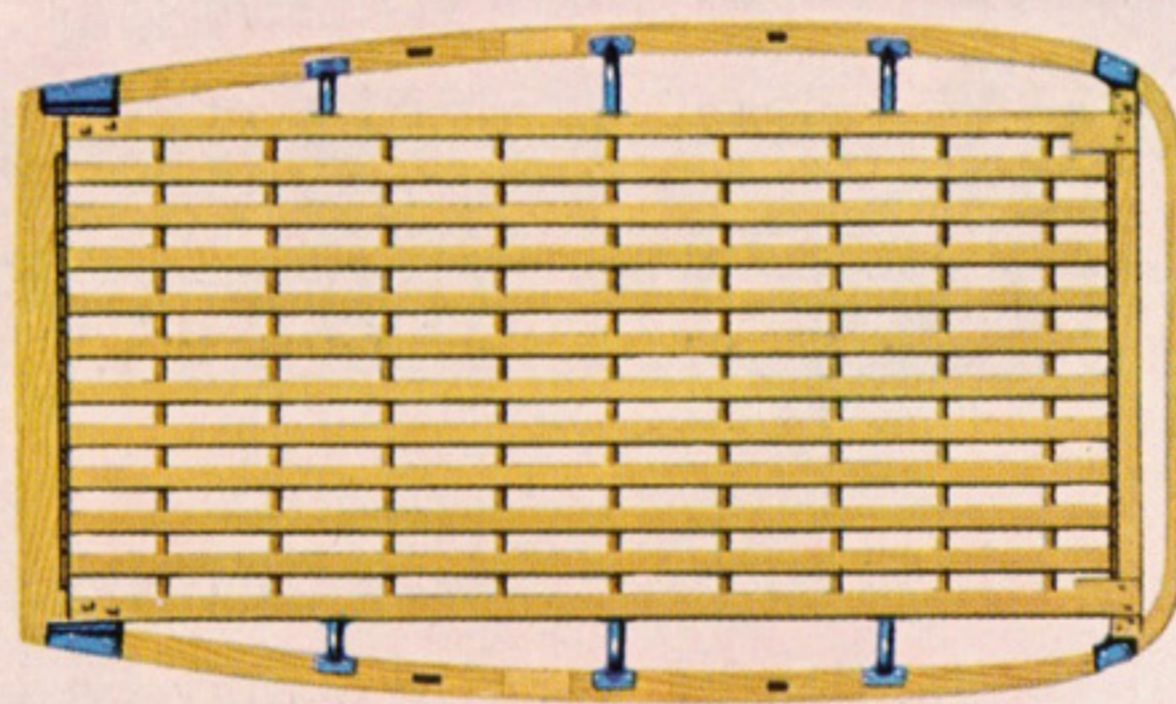

Slat-and-bow roof construction

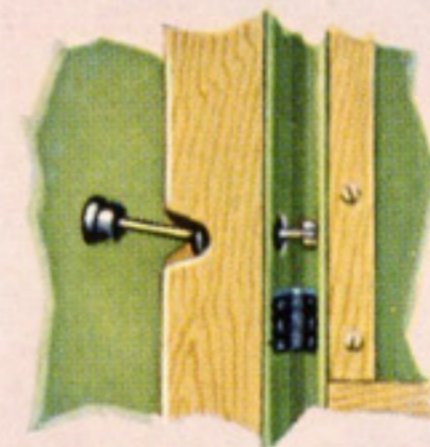

Rubber-cushioned door stop

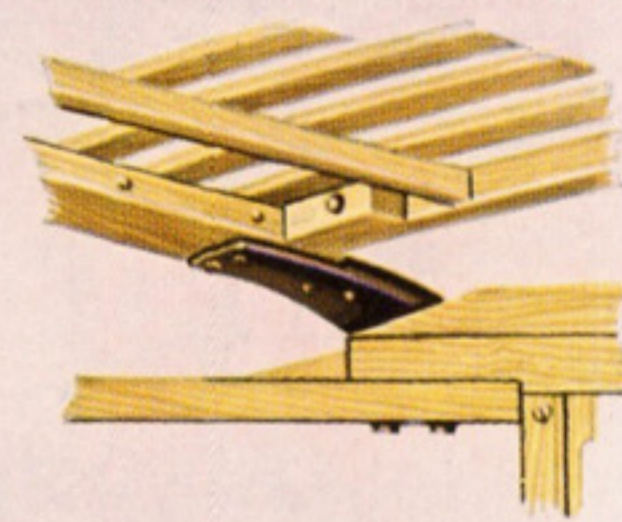

Rear roof corner brace

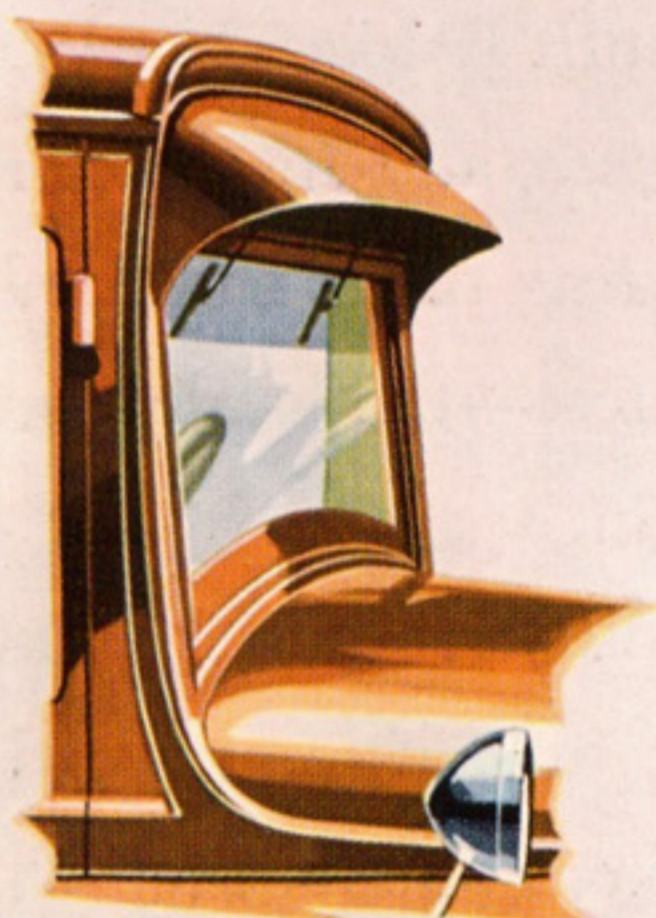

Fisher nonglare sloping windshield

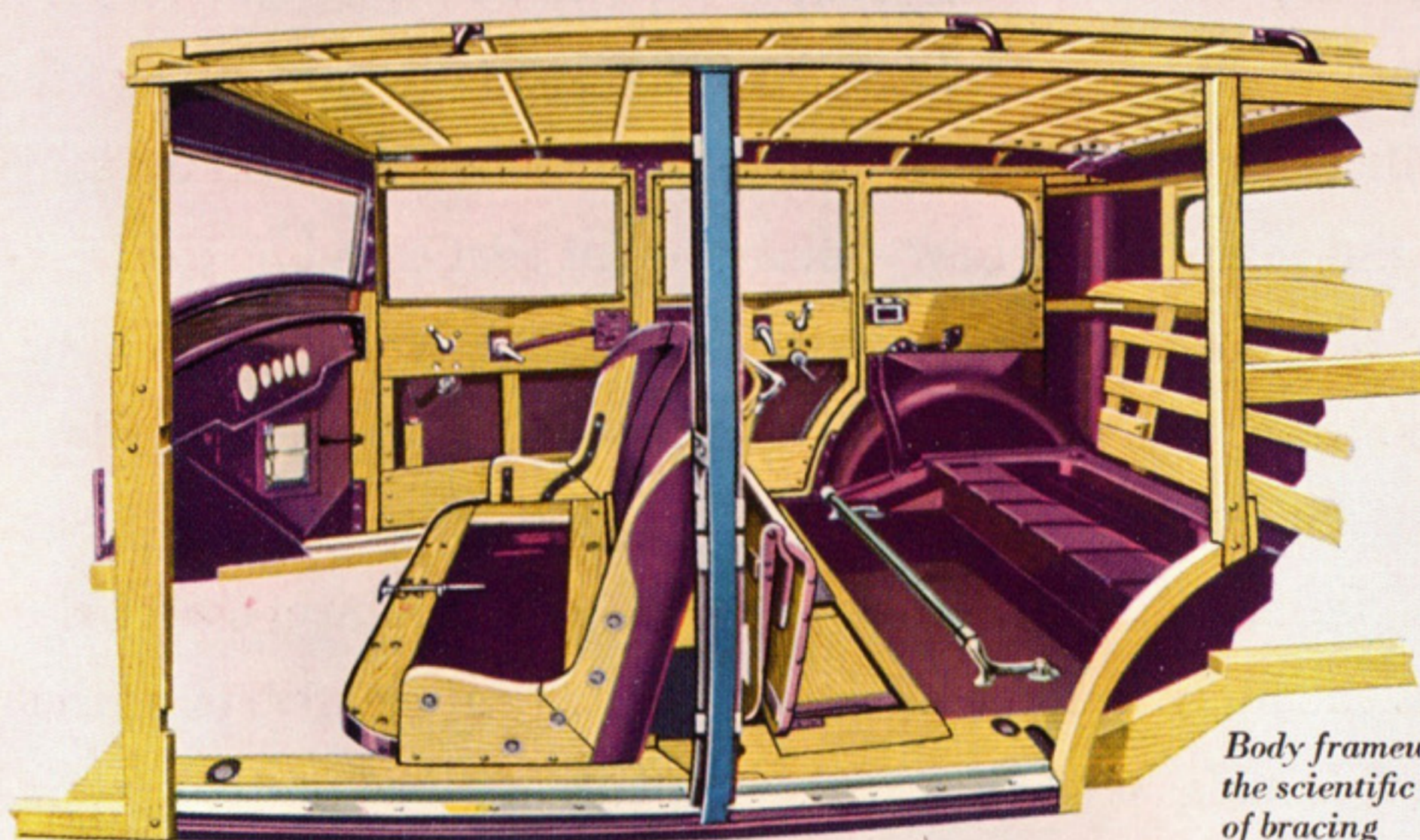

Body framework showing the scientific system of bracing

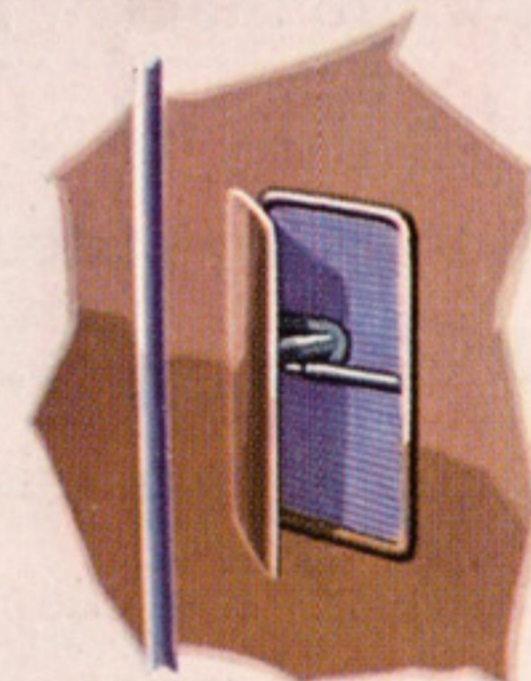

Cowl ventilator with screen

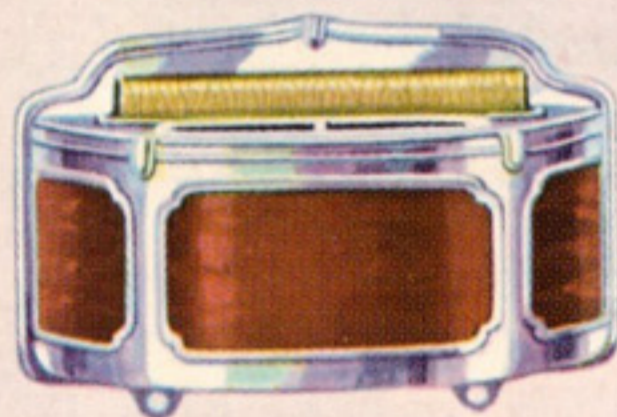

Vanity case

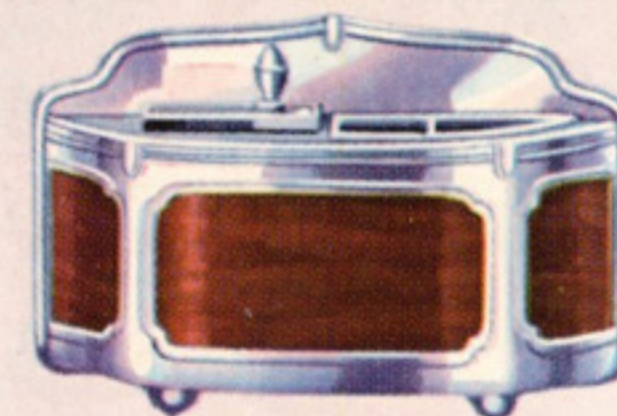

Smoking set



Windshield regulator

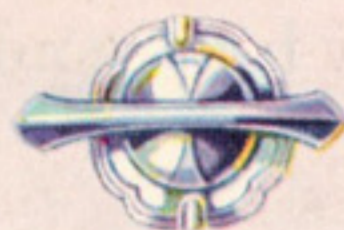

Rear quarter window regulator



Remote-control door handle



Adjustable driving seat



Door window regulator



Rear corner light

The metal paneling of the body has shared in the general development. The shroud and windshield post panels are made as one piece, adding greatly to the rigidity of the front of the body and eliminating the possibility of a joint cracking slightly, which might mar the finish and permit leakage.

The back and side quarter panels are also made in one piece, affording a very stiff construction and permitting the moldings to be pressed in the metal, instead of being attached separately.

The angle of the toe board in the driving compartment has been made still more comfortable, and the whole compartment has been effectively insulated against heat and cold as well as noise. The floor and toe board insulation is a combination of felt with a rubber mat. The dash insulation is a combination of felt and a special sound-absorbing material. Toe board supports assist the substantial bracing between the sills and the dash and help to make the front compartment exceptionally weathertight.

Among many important developments is the designing of the adjusting mechanism on the driving seats so that the seats are lower and have deeper, more comfortable cushions for greater riding ease.

Although the bodies are so sturdily constructed that adjustments are seldom likely to be needed, all points where looseness might in time develop have been made easily accessible from the inside without requiring the dismantling of large sections of the interiors, which is the common practice.

The fact that so many new developments are to be found in the Buick bodies by Fisher should not overshadow important features retained from former models. Outstanding among these is the Fisher VV windshield, which permits either direct or indirect ventilation, and which is set at an angle that keeps glare out of the driver's eyes. The adjustable driving seat and adjustable steering post are other important points, as they make each model adaptable to drivers of every height.

Many of the points that have been described will never come to the direct attention of most owners, but their value will be apparent in continuous motoring satisfaction over long periods of time.

They are fundamental contributions to motoring comfort and their importance is not lessened by the fact that they are concealed from view.

## SPECIFICATIONS

### 1931 Buick Valve-in-Head Straight Eights

SERIES 8-90 ON 132-INCH WHEEL BASE

SERIES 8-80 ON 124-INCH WHEEL BASE

SERIES 8-60 ON 118-INCH WHEEL BASE

#### ENGINE

*The Buick Valve-in-Head Straight-Eight engine in all Buick models for 1931 is the culmination of twenty-seven years' experience in developing the Valve-in-Head principle. It carries that principle forward to new triumphs. Making possible a consistent speed of 75 to 80 miles an hour, it is amazingly smooth and responsive—without question the greatest engine that Buick has ever built.*

**TYPE**—Buick Valve-in-Head, eight cylinders in line, cast as unit with upper half of crankcase. Four-point suspension with flexible rubber mountings.

**BORE AND STROKE**—Series 8-90 and 8-80:  $3\frac{5}{16}$  inches by 5 inches. Series 8-60:  $3\frac{1}{8}$  inches by  $4\frac{5}{8}$  inches.

**DISPLACEMENT**—Series 8-90 and 8-80: 344.8 cubic inches. Series 8-60: 272.6 cubic inches.

**HORSEPOWER**—Series 8-90 and 8-80: 104. Series 8-60: 90; permitting consistent speeds of 80 miles an hour.

**S.A.E. RATING**—Series 8-90 and 8-80: 35.12. Series 8-60: 30.02.

**PISTONS**—Cast iron, of special Buick design, with two compression rings and one oil ring (all above the pin).

**CONNECTING RODS**—Drop-forged from special steel, heat-treated. Improved I-beam type.

**VALVES**—Inlet: chrome nickel steel. Exhaust: silichrome No. 1 steel.

**CRANKSHAFT**—Drop-forged, heat-treated, and ground. Fully counterweighted and balanced with latest ring-type torsion balancer. Practically vibrationless.

**TIMING GEARS**—Positive drive. Silent. Require no adjustment.

**FUEL SYSTEM**—Marvel, dual-type carburetor. Maximum efficiency and economy. Automatic heat control and manual control on instrument board. AC fuel pump and gasoline strainer. Combined intake silencer and air cleaner.

**WATER COOLING SYSTEM**—Cellular-type radiator with new, rigid mounting. Shutters automatically controlled by new type thermostat and mounted in rigid frame, eliminating binding or distortion from road strain. Centrifugal pump driven from generator shaft. Four-blade fan driven by  $\frac{5}{8}$ -inch V-belt. Fan lubricated by self-contained oil pump.

**EXHAUST SYSTEM**—Specially designed for quietness without excessive back pressure. Tightly sealed joints. Special mountings to give proper support and eliminate noise.

#### POWER TRANSMISSION SYSTEM

*Buick, and only Buick, in its price class, can offer such a remarkable power transmission system. Every unit has been*

*designed and strengthened in line with the increased power of the engine. Every unit contributes to smoother, more dependable performance and easier handling.*

**TRANSMISSION**—Improved Syncro-Mesh, selective gear type, eliminating gear clashing and promoting quick get-away. Three speeds forward and one reverse. All gears chrome nickel steel, hardened and ground, insuring quietness and long life. Shaft mounted in ball bearings.

**CLUTCH**—Positive action, double-plate type on Series 8-90 and 8-80; single-plate on Series 8-60. Large surface area. Operates smoothly and easily. Specially designed by Buick in conjunction with the Syncro-Mesh transmission.

**TORQUE TUBE**—Fully enclosed propeller shaft, protecting it from dust, dirt, and water. Insures perfect alignment between propeller shaft and rear axle. Relieves springs of all driving strain. Has only one universal joint, automatically lubricated from transmission.

**REAR AXLE**—Three-quarter floating type. Car weight carried on axle housing, leaving axle shafts free to drive wheels. Improved, one-piece housing of pressed steel, exceptionally rigid and oiltight.

#### LUBRICATION SYSTEM

*At the consistent high speeds made possible by the Buick Valve-in-Head Straight-Eight engine, cooling of the oil in the engine is just as important as cooling of the water. Buick leads the automotive world in developing an Oil-Temperature Regulator that permits high-speed driving and lengthens the life of the engine. In conjunction with forced feed lubrication, oil filtering, and crankcase ventilation, it places Buick far ahead of all competition.*

**OIL-TEMPERATURE REGULATOR**—Keeps engine oil at normal operating temperature under all conditions. Permits constant high-speed driving without overheating and aids quick warm-up in cold weather. Increases life of bearings and working parts. Cooling is effected by water from radiator. No working parts. No attention required from owner.

**FEED**—35-lb. pressure from gear pump to main, connecting rod and camshaft bearings, rocker arm shaft, valve stems, timing gears, and generator front bearing.  $12\frac{1}{2}$ -quart oil capacity (nine-quart refill), Series 8-80 and 8-90. Series 8-60, capacity  $11\frac{1}{2}$  quarts (refill, eight quarts), assuring ample lubrication of cylinder walls and all other parts.

**OIL FILTER**—AC. Removes impurities from oil and protects working parts against abrasive action of dust and other matter.

**CRANKCASE VENTILATION**—Counterweights and balancer on crankshaft act as blower, forcing all fumes and vapor out of engine and entirely clear of car, preventing dilution of oil in crankcase. Only four oil changes a year needed, with oil added as required between changes.

**CHASSIS**—Zerk, centralized lubrication system, reaching every point positively and easily.

#### CHASSIS

*Into the foundation of the car—the chassis—Buick puts all the skill and knowledge acquired in twenty-seven years of honest*

*manufacturing. The frames of the 1931 Buicks are stronger and more rugged than ever. And similar extra strength and efficiency is found in all the other units which make up the chassis. The result is perfect coordination with the Buick Valve-in-Head Straight-Eight engine, making for smooth, dependable performance and unusually long life.*

**FRAME**—Double-drop type assuring ample head room with no sacrifice of road clearance. Made of heavy, pressed channel steel with six cross members. Center cross member is heavy box type. All other cross members increased in size and strength and connected to frame in new, rigid manner. Whole construction is exceptionally rugged.

**STEERING GEAR**—Worm-and-roller type with improved hardening and heat treatment, increased bearing surfaces, hardened steel bushings, steel retainers for thrust bearings, hardened bushings on roller shafts, new oil seals to prevent leakage. Every detail strengthened in line with increased power of engine.

**ROAD SHOCK ELIMINATOR**—Adds to ease of steering by absorbing the road shocks and prevents them from reaching the steering gear.

**FRONT AXLE**—Reverse Elliott type with carbon steel I-beam section, plain bronze knuckle bearings, vertical thrust ball bearings.

**FRONT SPRINGS**—Semi-elliptic overslung type. Series 8-90 and 8-80:  $37\frac{3}{8}$  inches long, 2 inches wide. Series 8-60:  $36\frac{7}{8}$  inches long, 2 inches wide. Bronze bushings.

**REAR SPRINGS**—Semi-elliptic underslung type. Series 8-90 and 8-80:  $58\frac{3}{8}$  inches long,  $2\frac{1}{4}$  inches wide. Series 8-60:  $55\frac{1}{4}$  inches long,  $2\frac{1}{4}$  inches wide. Bronze bushings.

**SHOCK ABSORBERS**—Double-acting, hydraulic type, front and rear, bolted to frame at cross members, reducing strains and deflections to a minimum.

**FOUR-WHEEL BRAKES**—Buick Controlled-Servo internal mechanical type controlled by foot pedal. Cable control for front brakes, enclosed in dirt-proof housing. New hook-up eliminates a set of brake rods and cross shaft, giving much neater appearance.

**HAND BRAKE**—Operates on all four wheels. Braking surface on Series 8-90 and 8-80: 187.6 square inches; Series 8-60: 154 square inches.

**TIRES**—Series 8-90 and 8-80: 19 x 6.50; Series 8-60: 19 x 5.50.

#### ELECTRICAL SYSTEM

*In its electrical system, as in other parts of the car, Buick has worked successfully toward the goal of simplicity and dependability.*

**EQUIPMENT**—Delco-Remy 6-volt, two-unit system. Manual gear starter drive. Thermostatic generator control. Double breaker arm distributor, single coil, and AC spark plugs. Double filament tilt-ray, fixed-focus, chromium-plated head lamps, 21-21 c.p. Stop lamp, 15 c.p. Direct and indirect lighting for instrument panel. Delco-Remy or Exide battery.

#### SPECIAL EQUIPMENT

Demountable wire, wood, and disc wheels, trunk rack, trunk, fender well, bumpers, heaters, metal and fabric tire covers, gravel deflectors, and clocks may be had at small additional cost.

## SPECIFICATIONS

### 1931 Buick Valve-in-Head Straight Eights

SERIES 8-50 ON 114-INCH WHEEL BASE

#### ENGINE

*The Buick Valve-in-Head Straight-Eight engine in all Buick models for 1931 is the culmination of twenty-seven years' experience in developing the Valve-in-Head principle. It carries that principle forward to new triumphs. Making possible a consistent speed of 75 miles an hour in the Series 8-50, it is amazingly smooth and responsive—without question the greatest engine that Buick has ever built.*

**TYPE**—Buick Valve-in-Head, eight cylinders in line, cast as unit with upper half of crankcase. Four-point suspension with flexible rubber mountings.

**BORE AND STROKE**— $2\frac{7}{8}$  inches by  $4\frac{1}{4}$  inches.

**DISPLACEMENT**—220.7 cubic inches.

**HORSEPOWER**—77; permitting consistent speeds of 75 miles an hour.

**S.A.E. RATING**—26.45.

**PISTONS**—Cast iron, of special Buick design, with two compression rings and one oil ring (all above the pin).

**CONNECTING RODS**—Drop-forged from special steel, heat-treated. Improved I-beam type.

**VALVES**—Inlet: chrome nickel steel. Exhaust: silichrome No. 1 steel.

**CRANKSHAFT**—Drop-forged, heat-treated, and ground. Fully counterweighted and balanced with latest ring-type torsion balancer. Practically vibrationless.

**TIMING GEARS**—Positive drive. Silent. Require no adjustment.

**FUEL SYSTEM**—Marvel carburetor. Automatic heat control and manual control on instrument board. AC fuel pump and gasoline strainer. Combined intake silencer and air cleaner. Gas tank capacity, 16 gallons.

**WATER COOLING SYSTEM**—Cellular-type radiator with new, rigid mounting. Shutters automatically controlled by new type thermostat and mounted in rigid frame, eliminating binding or distortion from road strain. Centrifugal pump driven from generator shaft. Four-blade fan, driven by  $\frac{5}{8}$ -inch V-belt. Fan lubricated by self-contained oil pump.

**EXHAUST SYSTEM**—Specially designed for quietness without excessive back pressure. Tightly sealed joints. Special mountings to give proper support and eliminate noise.

#### POWER TRANSMISSION SYSTEM

*To take full advantage of the smooth power from the Buick Valve-in-Head Straight-Eight engine, the power transmission system has been developed with characteristic Buick thorough-*

*ness. Easy handling, complete dependability, and long life are assured by the design of the various units and the high quality of the materials from which they are constructed.*

**TRANSMISSION**—Sliding, selective gear type. Three speeds forward and one reverse. All gears chrome steel, hardened and ground, insuring quietness and long life. Shaft mounted in ball bearings.

**CLUTCH**—Positive action, single-plate type with more than 80 square inches surface area. Operates smoothly and easily.

**REAR AXLE**—Semi-floating type. Improved, one-piece housing of pressed steel, exceptionally rigid and oiltight.

#### LUBRICATION SYSTEM

*At the consistent high speeds made possible by the Buick Valve-in-Head Straight-Eight engine, cooling of the oil in the engine is just as important as cooling of the water. Buick leads the automotive world in developing an Oil-Temperature Regulator that permits high-speed driving and lengthens the life of the engine. In conjunction with forced feed lubrication, oil filtering, and crankcase ventilation, it places Buick far ahead of all competition.*

**OIL-TEMPERATURE REGULATOR**—Keeps engine oil at normal operating temperatures under all conditions. Permits constant, high-speed driving without overheating and aids quick warm-up in cold weather. Increases life of bearings and working parts. Cooling is effected by water from radiator. No working parts. No attention required from owner.

**FEED**—35-lb. pressure from gear pump to main, connecting rod and camshaft bearings, rocker arm shaft, valve stems, timing gears, and generator front bearing. Nine-quart oil capacity (seven-quart refill), assuring ample lubrication of cylinder walls and all other parts.

**OIL FILTER**—AC. Removes impurities from oil and protects working parts against abrasive action of dust and other matter.

**CRANKCASE VENTILATION**—Counterweights and balancer on crankshaft act as blower, forcing all fumes and vapor out of engine and entirely clear of car, preventing dilution of oil in crankcase. Only four oil changes a year needed, with oil added as required between changes.

**CHASSIS**—Zerk, lubrication system, reaching every point positively and easily.

#### CHASSIS

*Into the foundation of the car—the chassis—Buick puts all the skill and knowledge acquired in twenty-seven years of honest manufacturing. The frames of the 1931 Buicks are stronger and more rugged than ever. And similar extra strength and efficiency are found in all the other units which make up the chassis. The result is perfect coordination with the Buick Valve-in-Head Straight-Eight engine, making for smooth, dependable performance and unusually long life.*

**FRAME**—Single-drop type. Ample head room with no sacrifice of road clearance. Made of heavy, pressed channel steel with all cross members increased in size and strength and connected to

frame in new, rigid manner. Whole construction is exceptionally rugged.

**STEERING GEAR**—Worm-and-sector type. Every detail strengthened in line with increased power of engine.

**FRONT AXLE**—Reverse Elliott type with carbon steel I-beam section, plain bronze knuckle bearings, vertical thrust ball bearings.

**FRONT SPRINGS**—Semi-elliptic overslung type: 35 inches long, 2 inches wide. Bronze bushings. Self-adjusting shackles at rear.

**REAR SPRINGS**—Semi-elliptic underslung type:  $54\frac{1}{2}$  inches long, 2 inches wide. Bronze bushings. Self-adjusting shackles at rear.

**SHOCK ABSORBERS**—Hydraulic type, front and rear, bolted securely to frame.

**FOUR-WHEEL BRAKES**—Buick Duo-Servo internal mechanical type, controlled by foot pedal. Cable control for front brakes, enclosed in dirt-proof housing. New hook-up eliminates a set of brake rods and cross shaft, giving much neater appearance. Braking surface, 182 square inches.

**HAND BRAKE**—Operates on all four wheels.

**TIRES**—18 x 5.25—4-ply.

#### ELECTRICAL SYSTEM

*In its electrical system, as in other parts of the car, Buick has worked successfully toward the goal of simplicity and dependability.*

**EQUIPMENT**—Delco-Remy 6-volt, 2-unit system. Manual starter drive. Thermostatic generator control. Double breaker arm distributor, single coil, and AC spark plugs. Double filament tilt-ray, fixed-focus, chromium-plated head lamps, 21-21 c.p. Stop lamp, 15 c.p. Direct and indirect lighting for instrument panel. Thirteen-plate Delco-Remy or Exide battery.

#### SPECIAL EQUIPMENT

Demountable wire, wood, and disc wheels, trunk rack, trunk, fender wells, bumpers, heaters, gravel deflectors, metal and fabric tire covers, and clocks may be had at small additional cost.

All facts in this book have been checked, but are subject to correction.

*The Buick Motor Company reserves the right to make changes in specifications at any time without incurring any obligation to install same on cars previously sold*

**BUICK MOTOR COMPANY**

*Division of General Motors Corporation*

**FLINT, MICH.**

When better automobiles are built, Buick will build them