



LAFAYETTE

NASH - BUILT



**ENTIRELY NEW IN LOW-PRICED CARS —
THESE COSTLY “BIG CAR” FEATURES**

WHAT YOU SEE at a glance in this remarkable new car—the obvious points that impress you immediately—seem all important at first:

Its surprising bigness and beauty; its air of speed and reserve power. And without question the new LaFayette is outstanding in these self-evident things. It is a *bigger* low-priced car. Its sheer size at once sets it apart from other cars in the same price class. And the swank of its “Slipstream” lines makes it unique.

But actually what is most unusual in this new LaFayette is not at all self-evident—except to an automotive engineer. It brings you a series of costly construction features* formerly found only in high-priced cars. Their function in an automobile is the same as that of jewels in a fine watch movement. They underlie the effortless, trouble-free power, the long-life, noiseless performance, the luxurious riding comfort

for which you ordinarily pay extra in bigger, more expensive cars.

These “big car” features can be offered in the new LaFayette because it is built by Nash. For years The Nash Motors Company has concentrated on making high-quality cars, has developed exceptional skill in simplifying processes of manufacture. All the special features of the new LaFayette, all the vital parts, have been tried and proven by Nash over a period of years.

In the extra size and beauty of the new LaFayette, in its mechanical perfection, in every detail of its appointments and accessories, there is an extraordinary value which cannot be obtained in any other way at the same price. The Nash Motors Company, Kenosha, Wis.

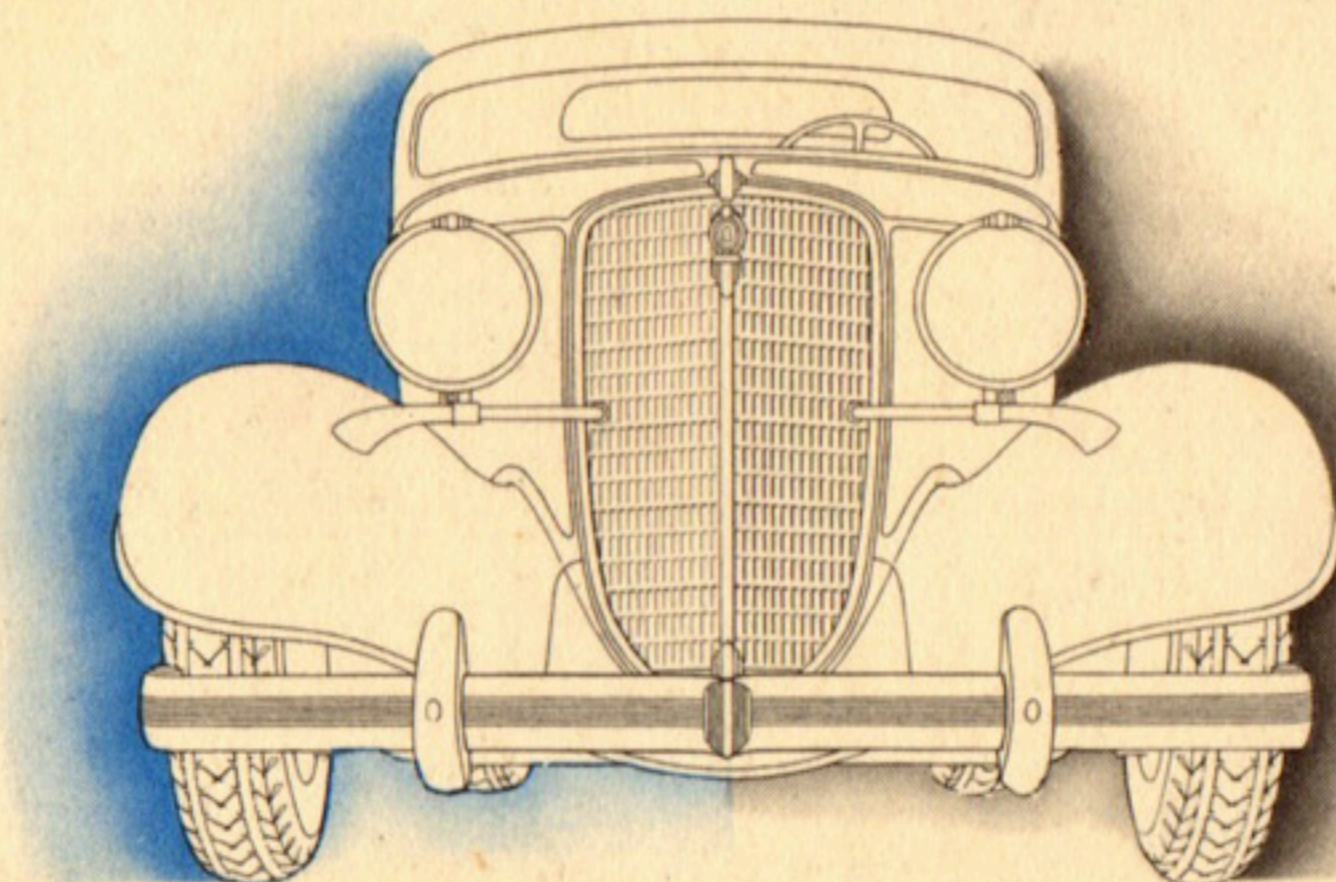

*Special “big car” features of the new LaFayette: Seven-bearing, extra-size crankshaft, fully counterbalanced; complete force-feed lubrication of engine with rifle-bored connecting rods; metered pressure cooling of engine; Invar Struts in aluminum pistons; Nash precision machining throughout; automatic and thermostatic control shock absorbers; steering road shock eliminator; metal encased springs equipped with lubricating inserts; worm and roller type steering gear; Seaman sound-proofed body—composite wood and steel construction.

★

LAFAYETTE

★ ★ ★

★

NASH BUILT

A FINE NAME — A FINE CAR

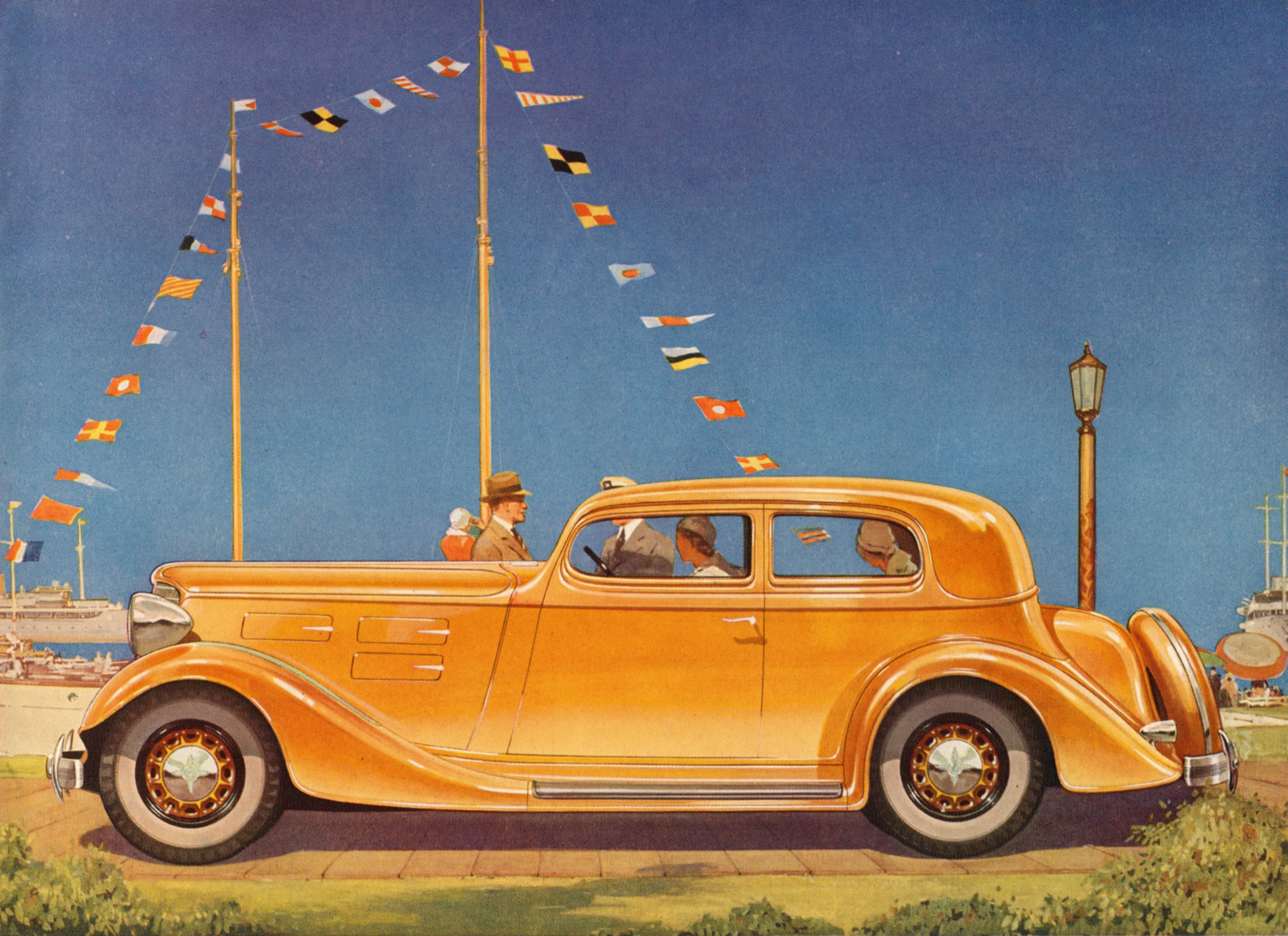

FIVE-PASSENGER TOURING SEDAN

with built-in trunk—see details of trunk on page 7

Luxurious interiors in special, sound-proofed bodies

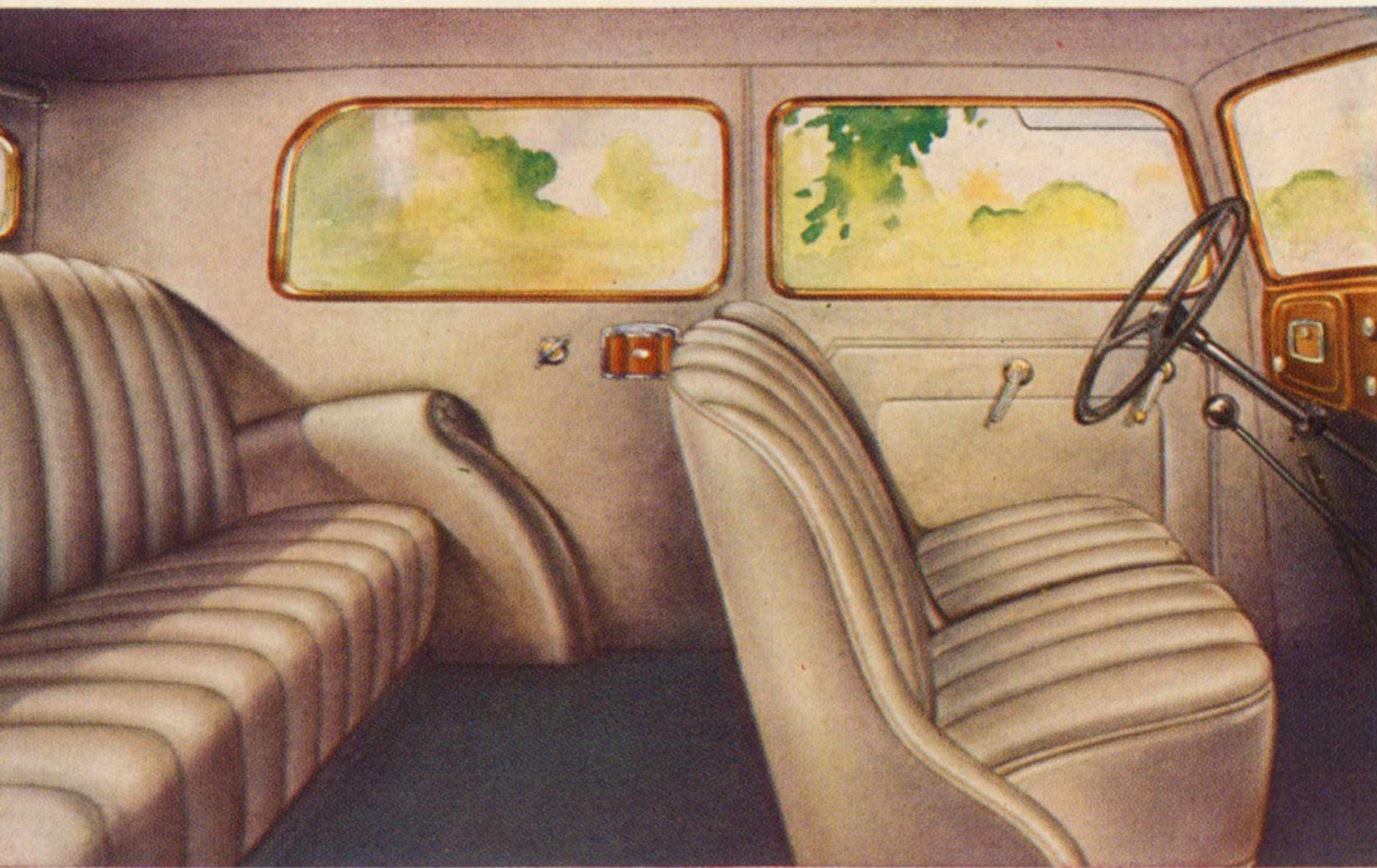

This smart, inviting interior of the Touring Sedan and the Two-door Sedan well illustrates the unusual beauty and comfort of all LaFayette models. Equally important is the remarkable sound-proofed construction—composite steel and wood—of the Seaman bodies

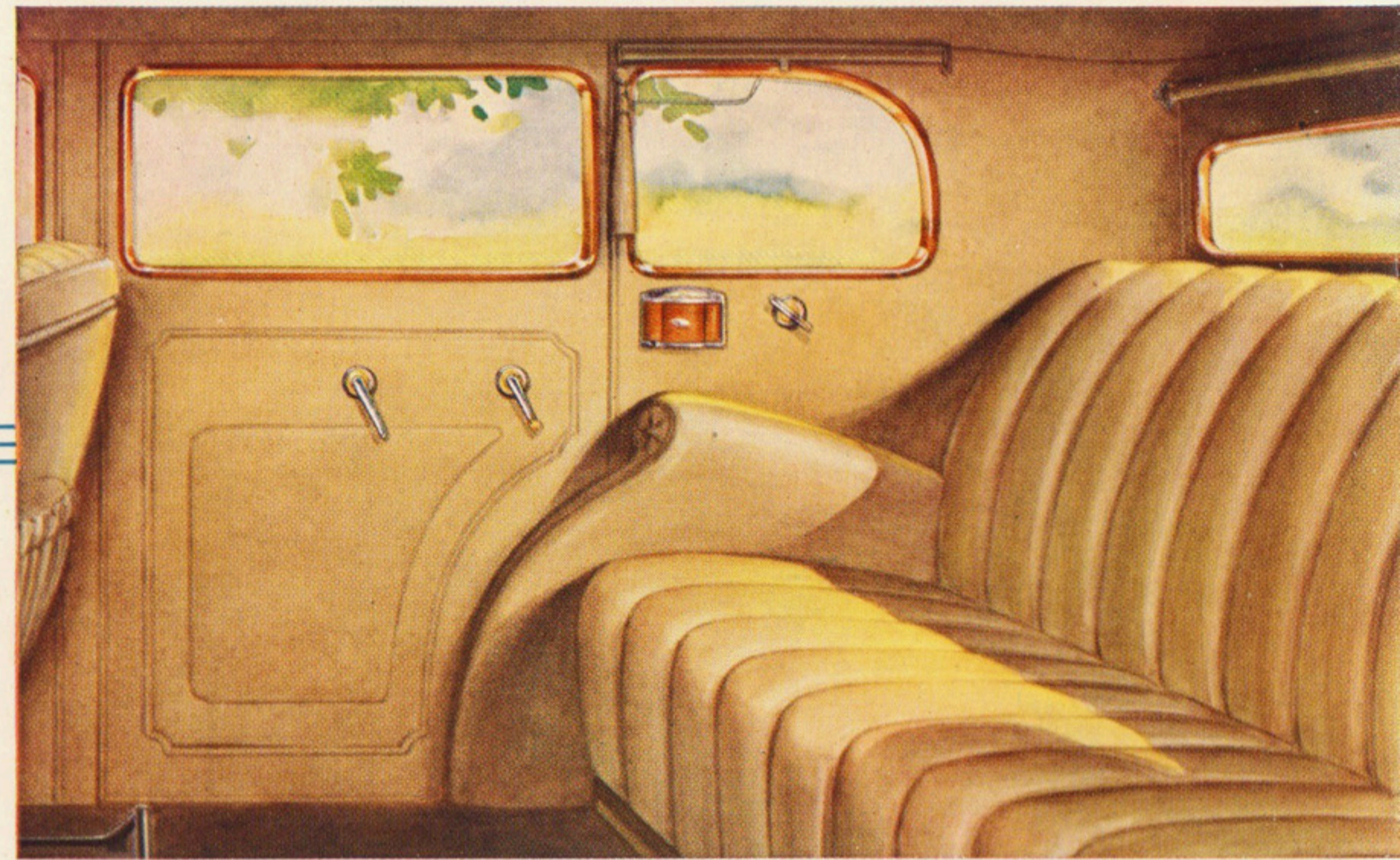

Extra leg-room, actual "big car" spaciousness, are features of all LaFayette interiors. Note also, in the Four-door Sedan shown above, the luxury of the deep rear seat upholstered in rich broadcloth



The roomy interior of the LaFayette Coupe has a refreshing charm all its own which makes you want to get in at once and drive away. Like all LaFayette models, it has Nash draftless, clear-vision ventilation with patented "Air Vents." (See page 7.)

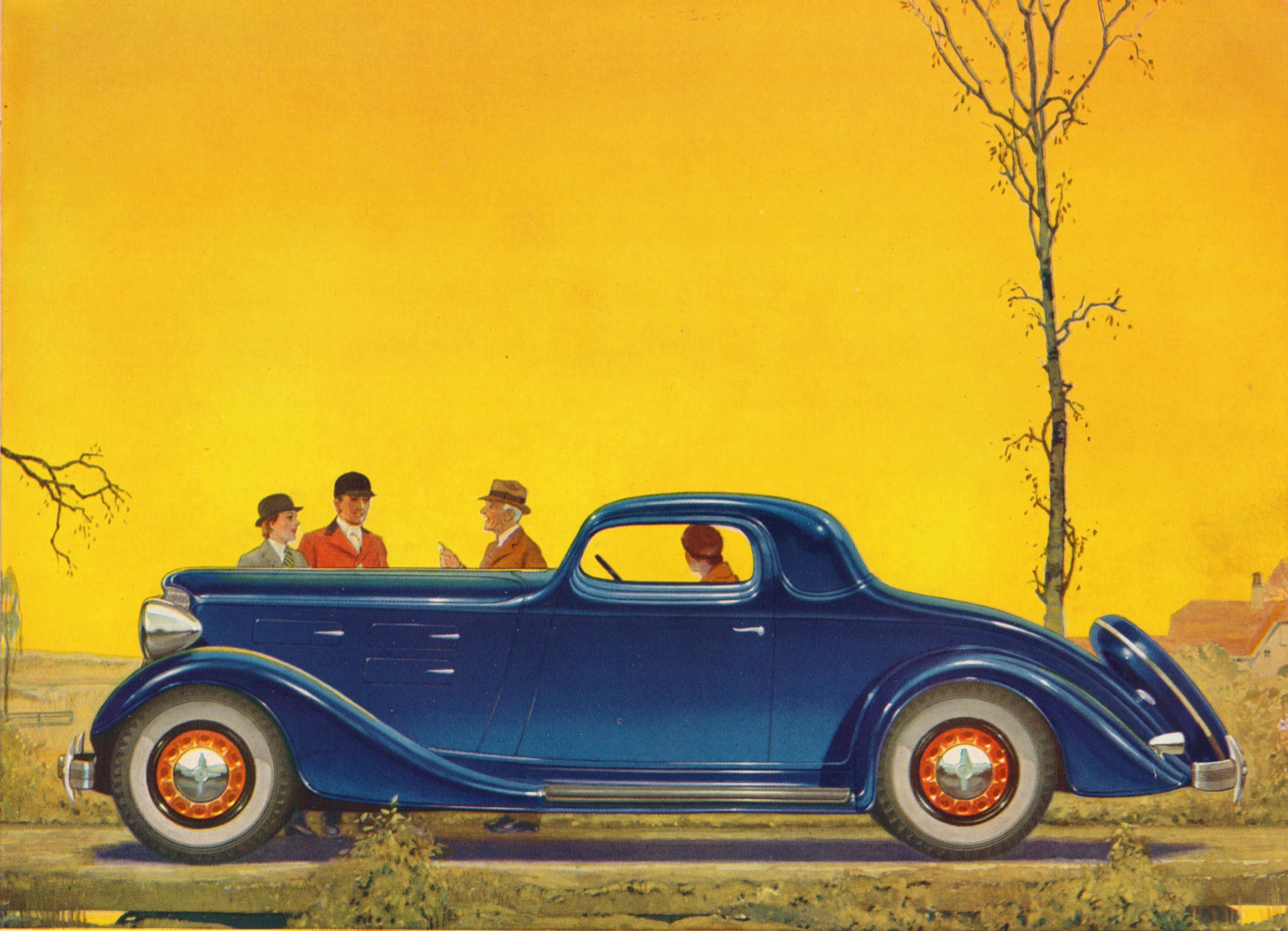

COUPE { **TWO-PASSENGER** with baggage compartment
FOUR-PASSENGER (rumble seat)

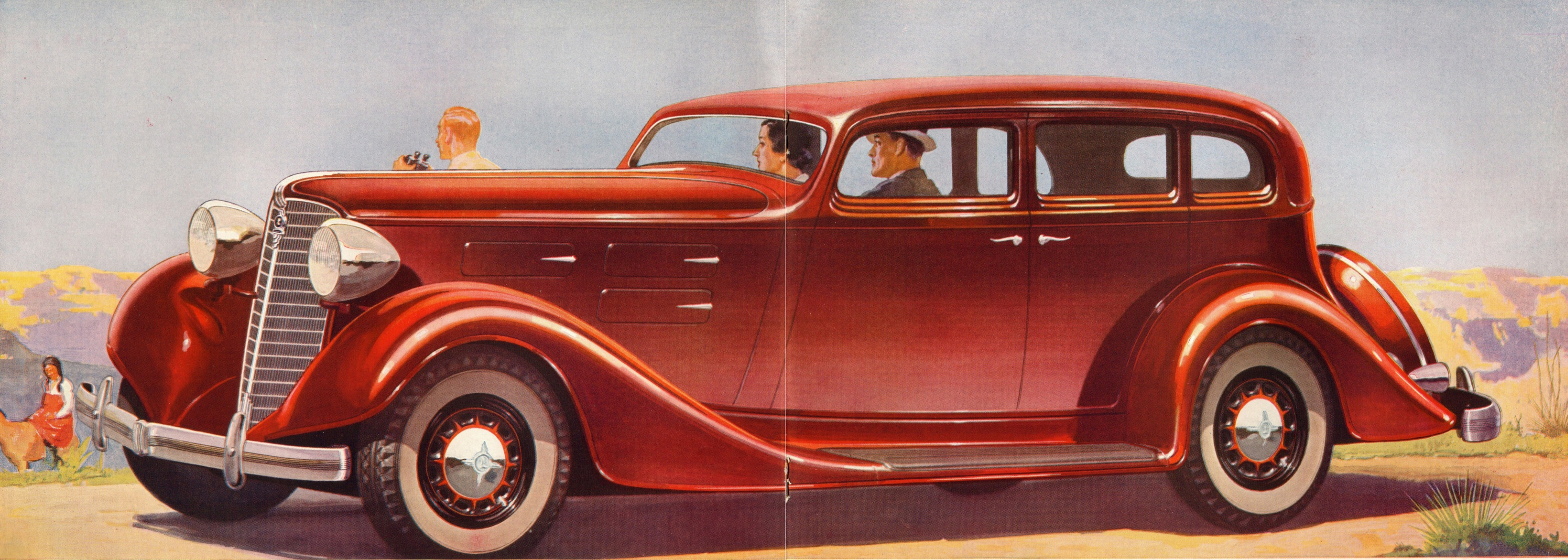

FIVE-PASSENGER, FOUR-DOOR SEDAN

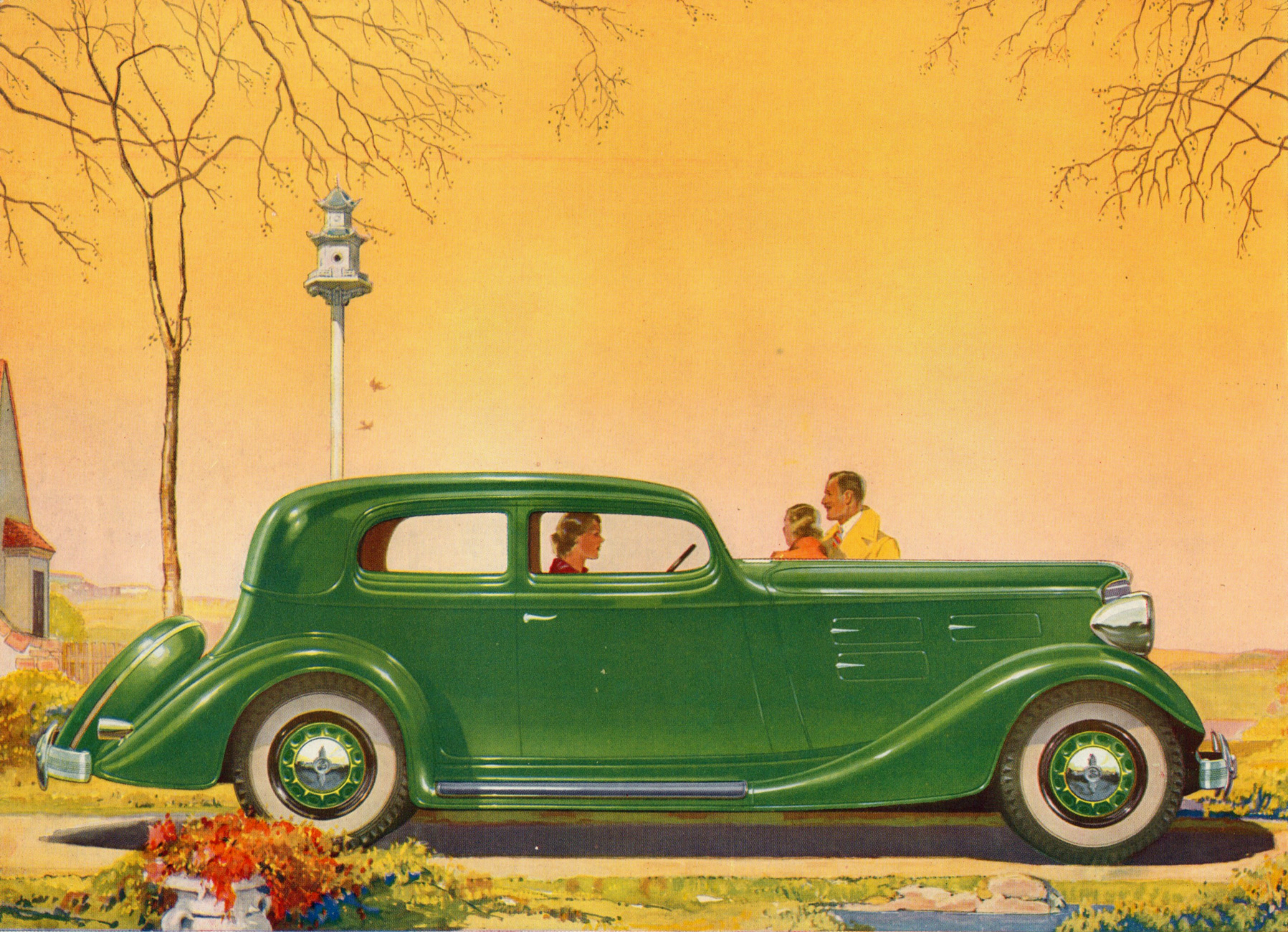

FIVE-PASSENGER, TWO-DOOR SEDAN

New refinements that mean new pleasure in driving

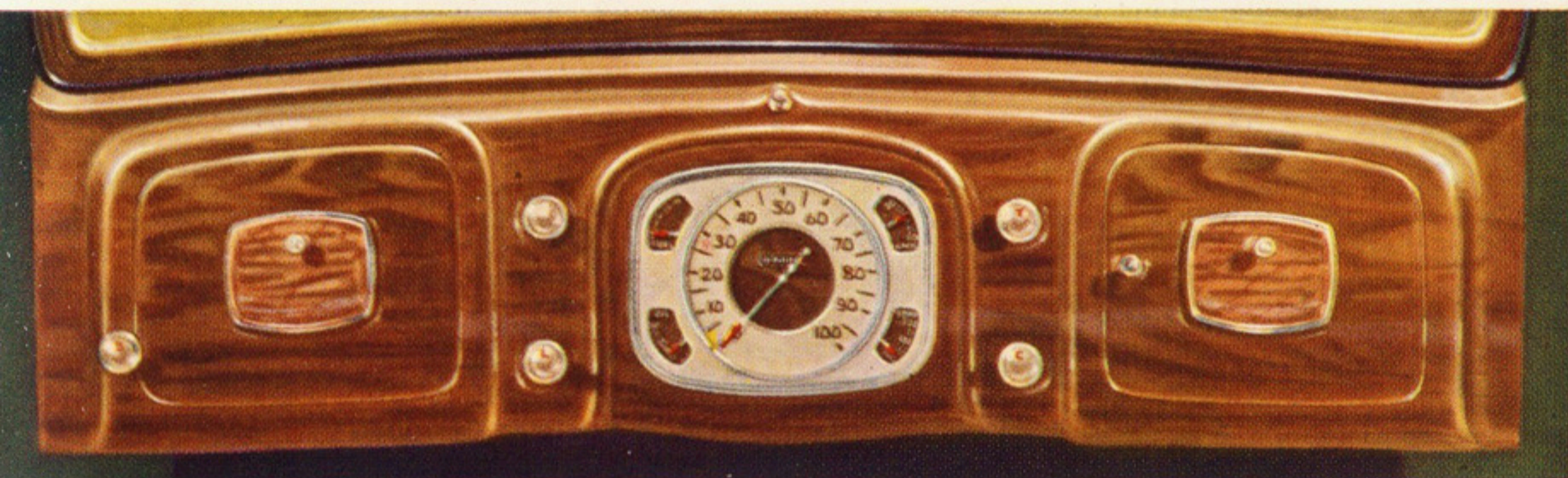

A large airplane-type speedometer, translucently lighted, is the central feature of the LaFayette instrument board. Around it are grouped the oil pressure gauge, the electric gasoline gauge, the ammeter and engine water temperature indicator



An added convenience for night driving! See night illumination at left. Special translucent lighting of LaFayette speedometer and indirect lighting of gauges make quick reading easy

Notice the unusual size of this package compartment located at the right of the speedometer. It's really made for packages!

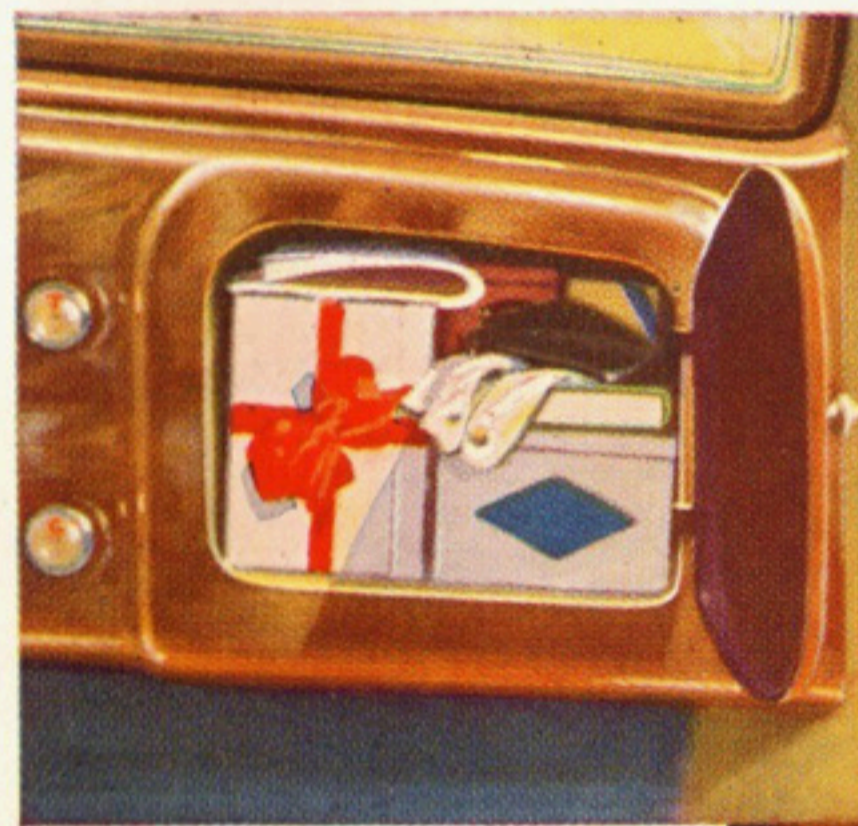

Patented "Air Vents" (below) insure draftless, quiet ventilation in cold or stormy weather—without obstructing vision. They are placed in the front and rear quarter windows of Four-door Sedans and in door windows of Coupes and Two-door Sedans

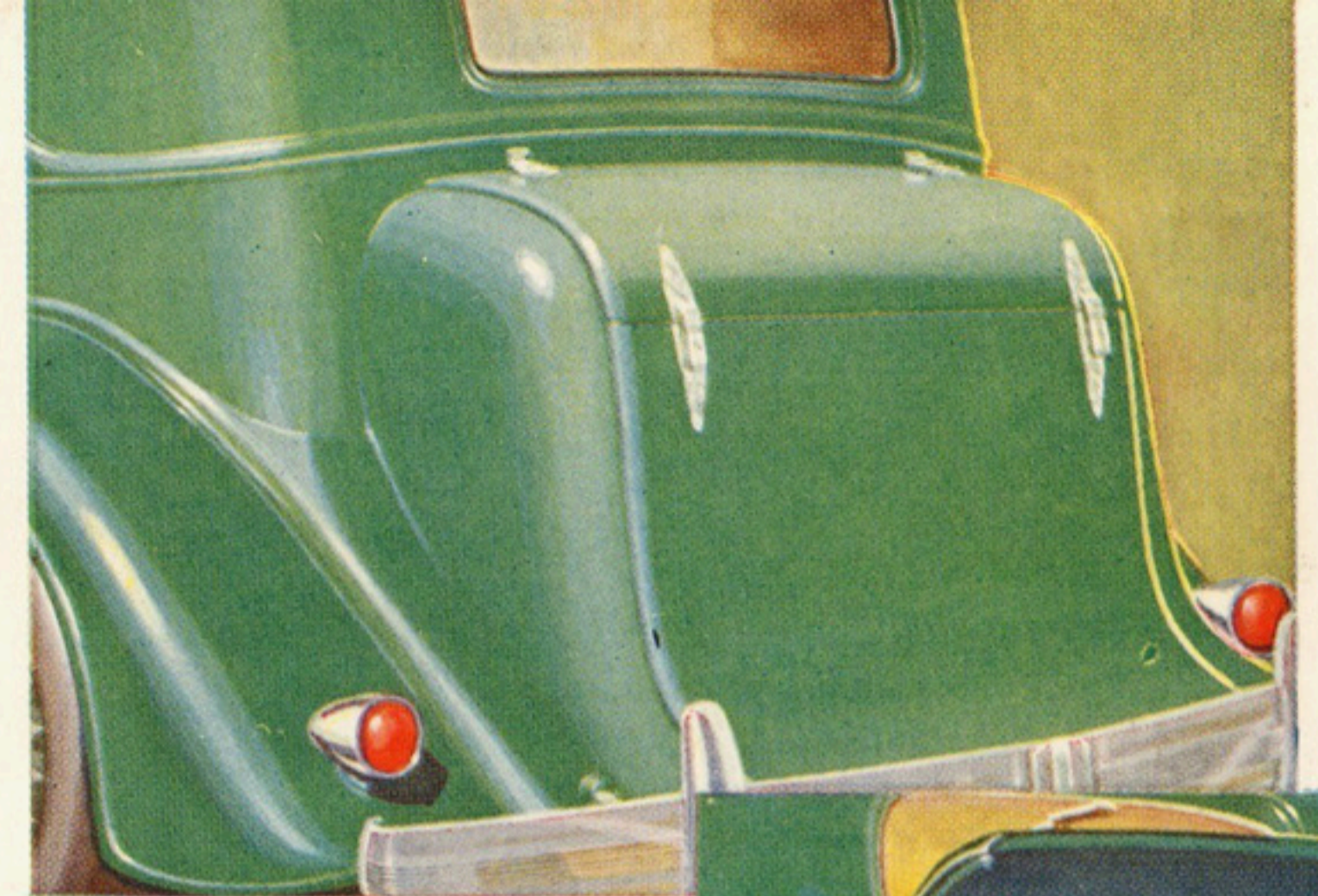

This smart trunk is built into the LaFayette Touring Sedan—a definite and lovely feature of its "Slipstream" lines



Pictured beside this new-style trunk are the things it will actually hold. Here's a trunk that really is a trunk. It is amazingly big, extending part way under the rear seat

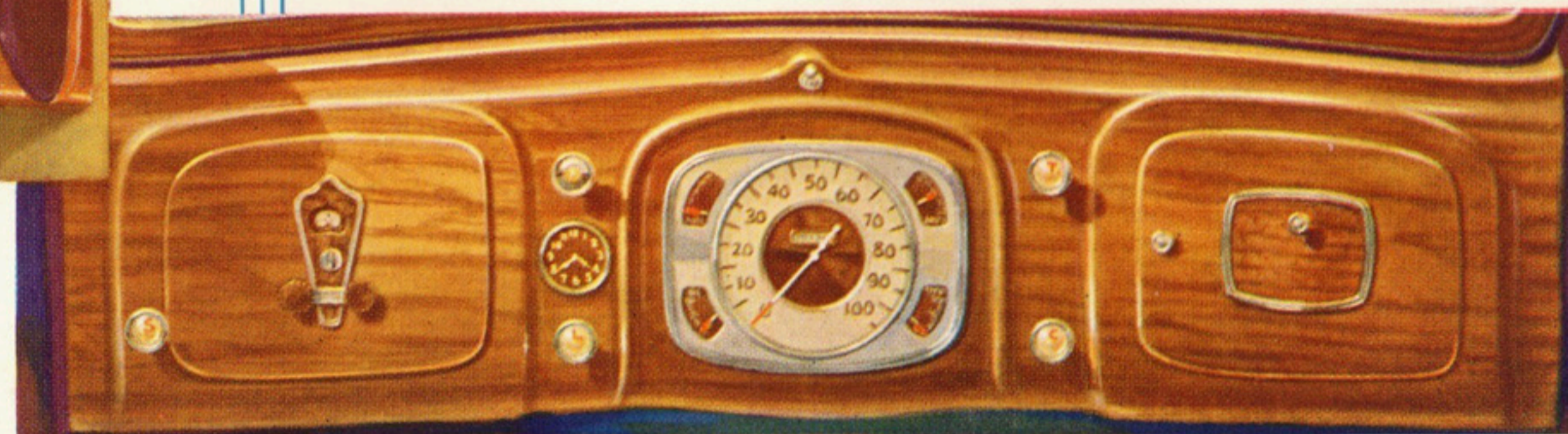

De Luxe instrument panel with electric clock and cigar lighter. Obtainable in all models at extra charge as part of LaFayette De Luxe equipment. Radio equipment is available at extra charge in all LaFayettes—standard or De Luxe. Control dials are shown at left of panel above

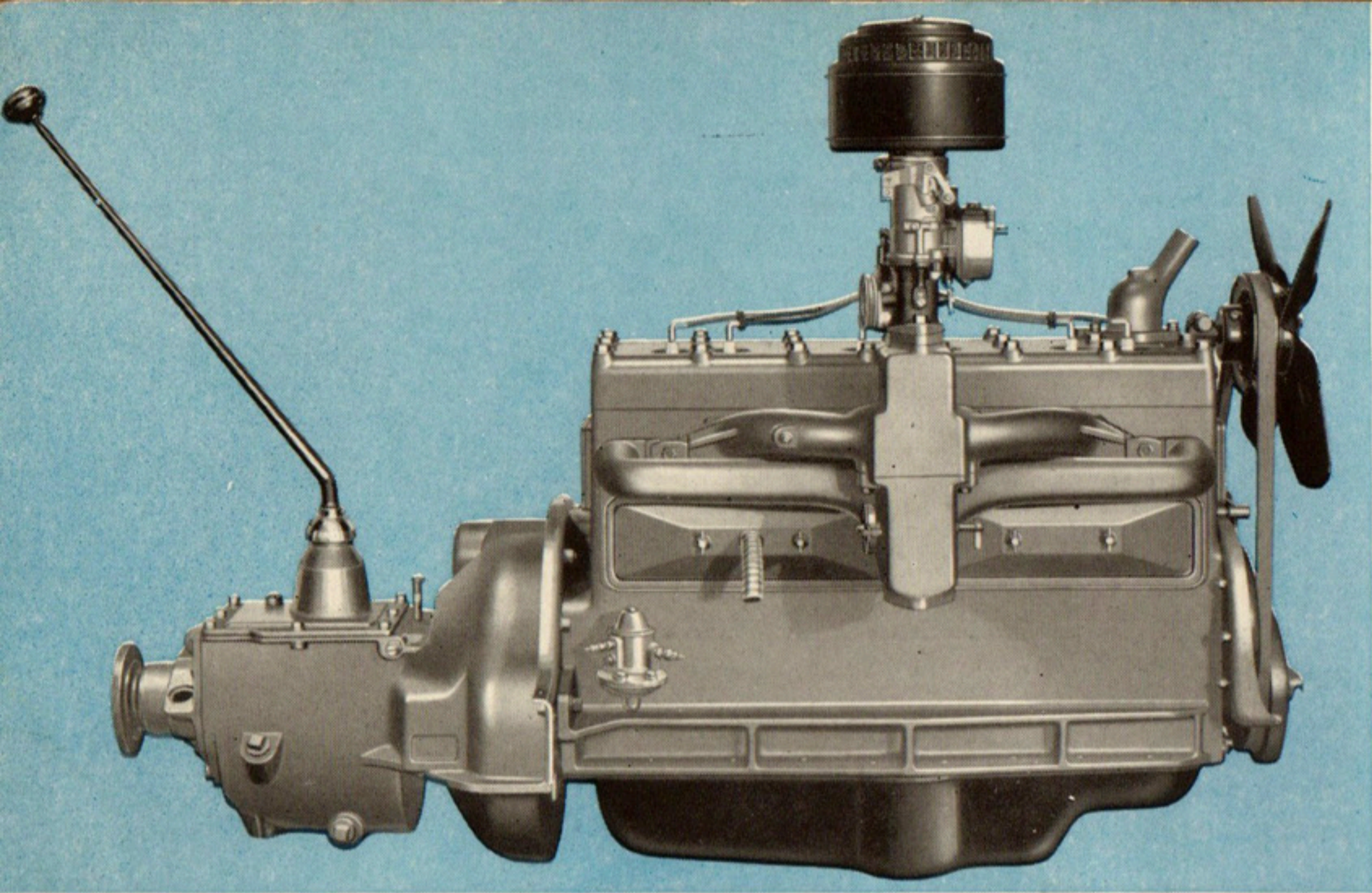

Above: Many "big car" features, vital to long life and smooth, silent operation, are embodied in the 6 cylinder, 75 horsepower engine of the LaFayette. For example: Metered pressure cooling that reduces temperature variation between front and rear cylinders to 5°; extra-rugged engine block, full-ribbed; complete force-feed lubrication

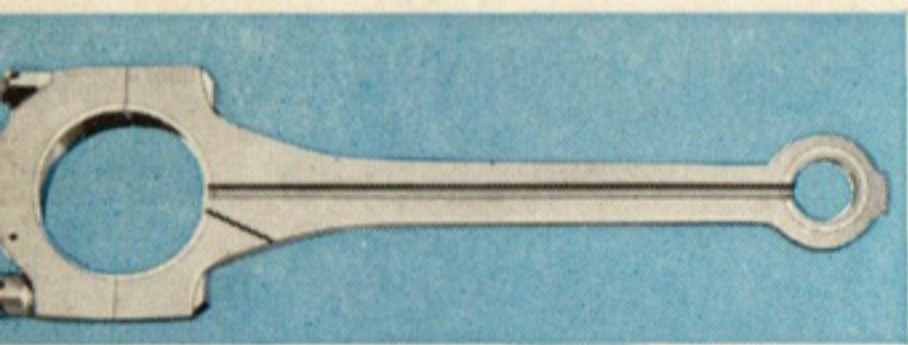

Left: Important to the long-life, quiet performance of the LaFayette engine is its complete force-feed lubrication system. The rifle-boring of the connecting rod, shown in cross section at left, is one of the features of this system which are unique in low-priced cars

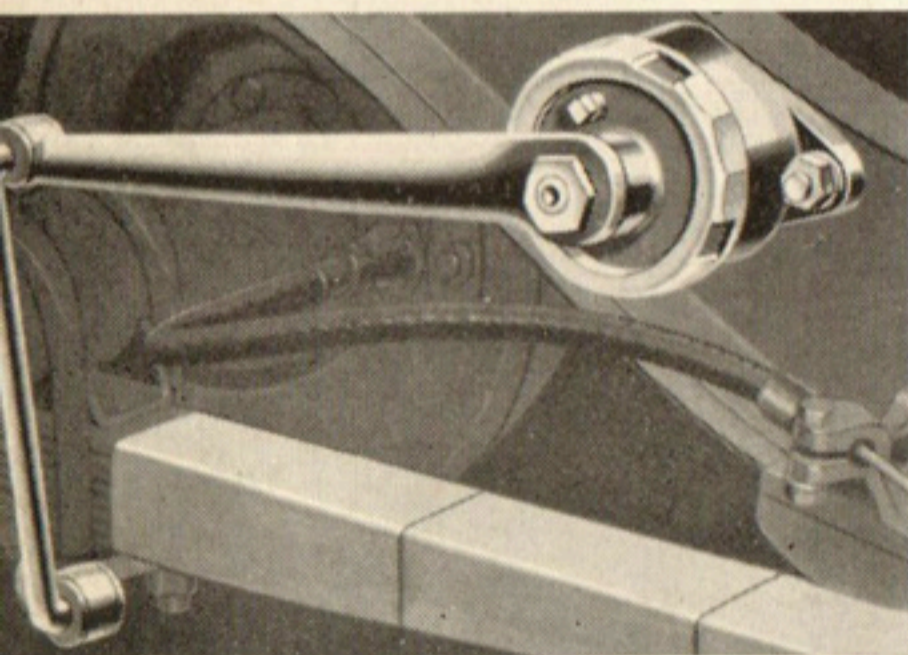

Right: To give you quicker get-away, LaFayette pistons are featherlight—made of aluminum. For smoother, greater power, special Invar Struts, inside these pistons, minimize expansion and contraction under changing engine temperatures



Above: Checked to within 1/20 of a hair's thickness—the LaFayette piston pin! Nash precision machining can be matched in many instances only by the workmanship in the finest watches

Above: Two extra precautions that insure easier, smoother riding in the LaFayette: (1) Hydraulic shock absorbers, double controlled—automatically for changes in load, road and speed, thermostatically for changes in temperature; (2) long springs, metal encased and equipped with lubricating inserts between end leaves

Right: Added safety, added years of life for body and chassis, new protection against road twist—these are the advantages of this X-Dual frame in the LaFayette. It has been called "the strongest backbone in any car"

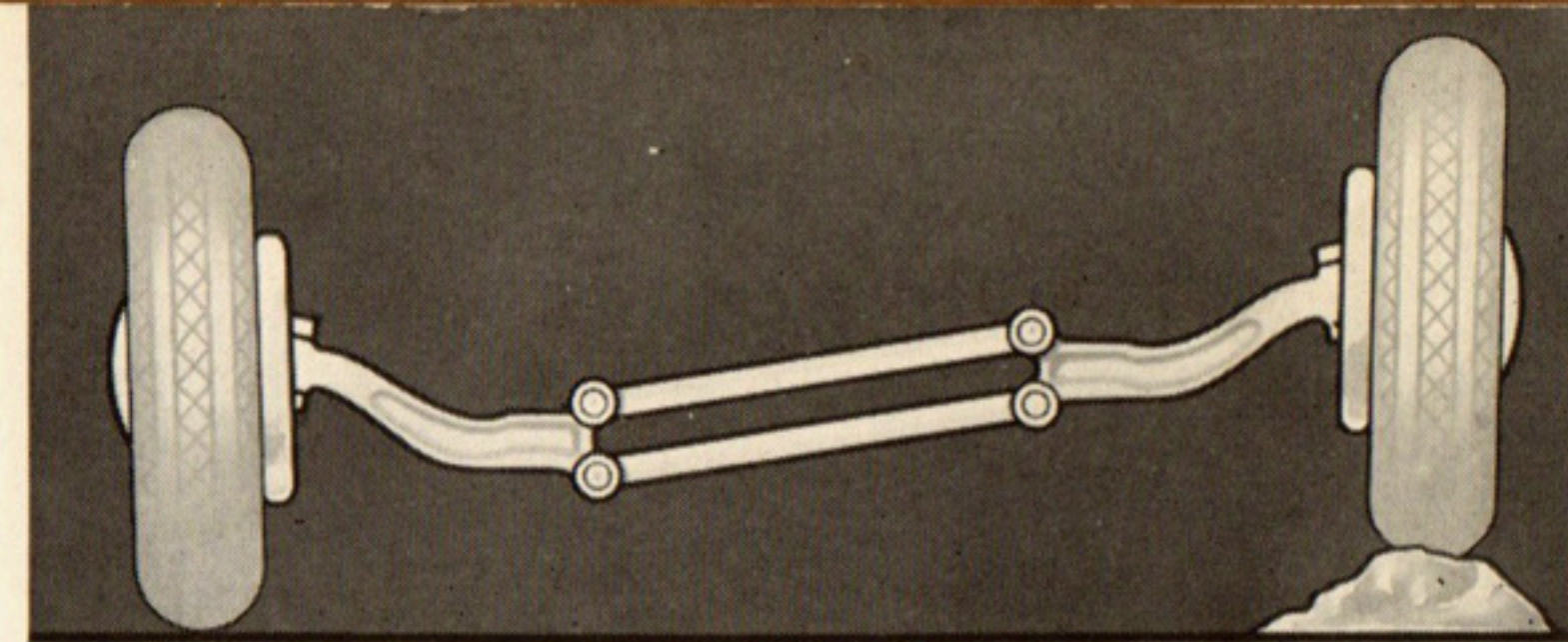
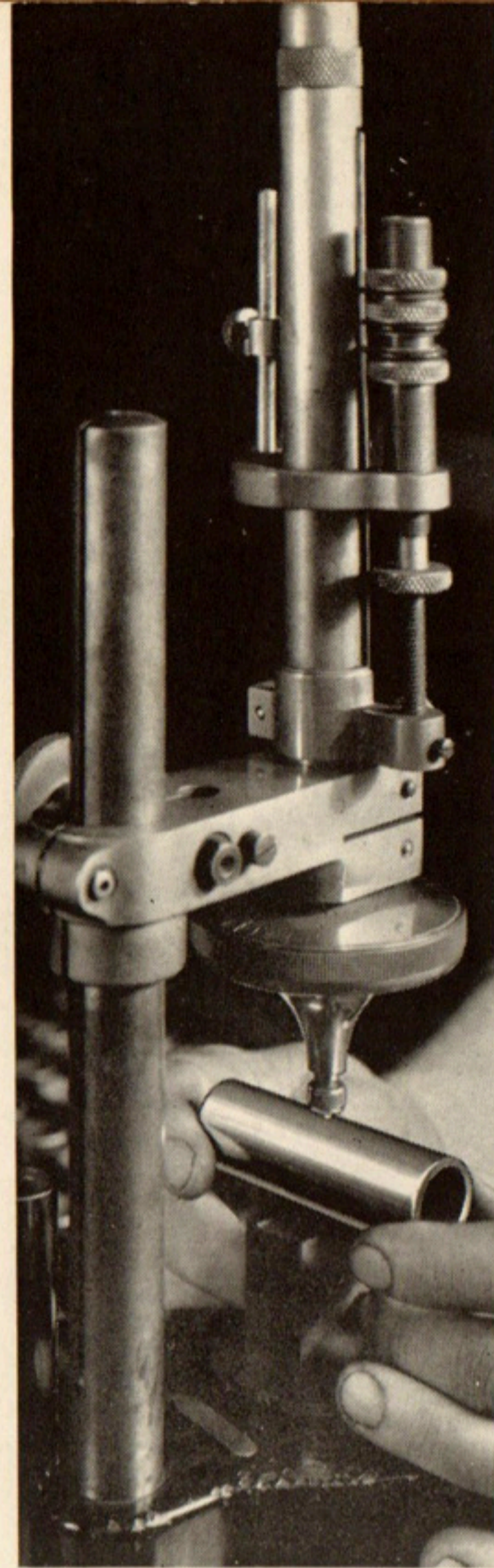
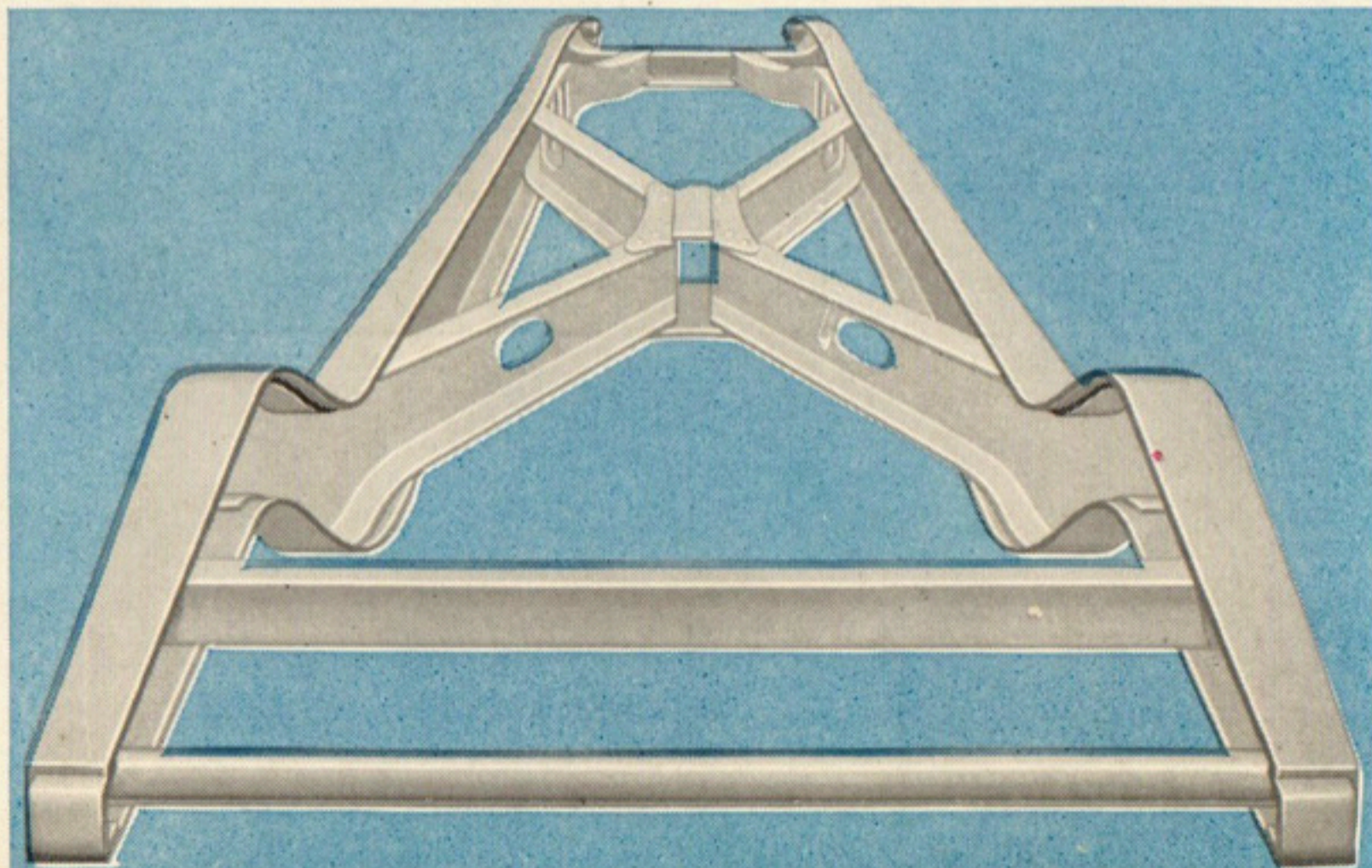

Above: Individually-sprung front wheels, as illustrated in this picture, are optional equipment in all LaFayette models at a slight extra charge

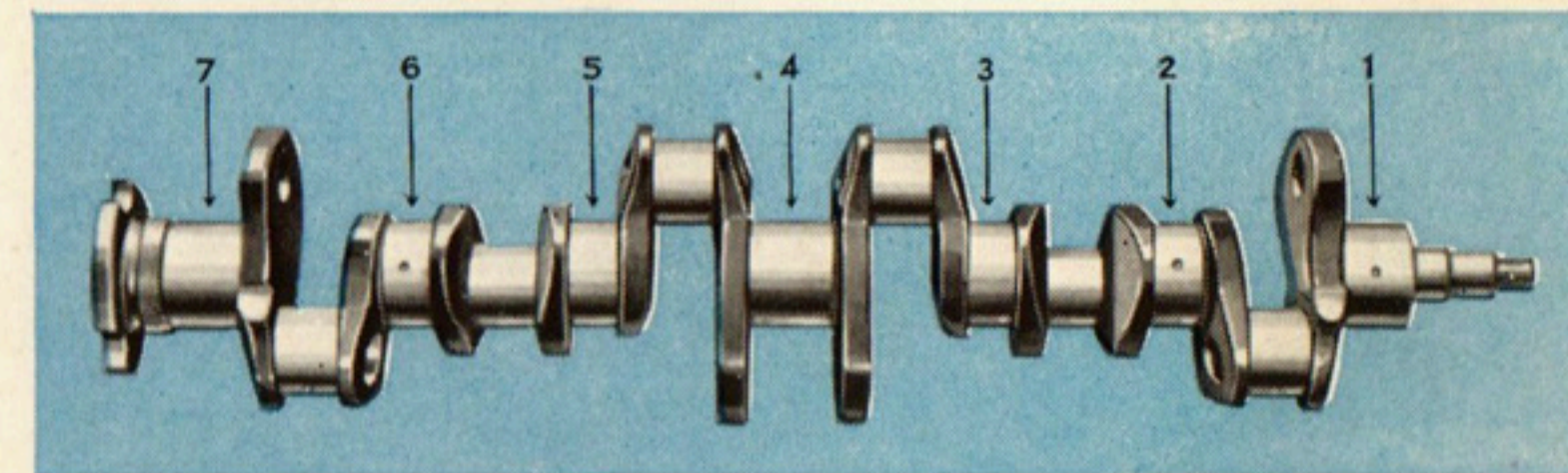

Above: Several features of this crankshaft are unique in the low-priced car field—features that mean added smoothness and longer life for the LaFayette engine: The crankshaft has a larger number of main bearings, seven in all; it is oversize; and it is fully counterbalanced

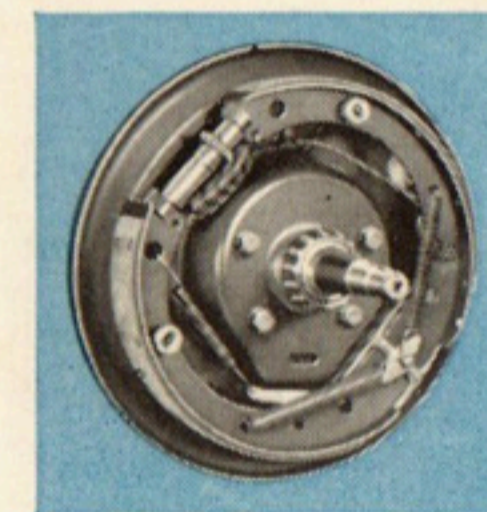

Right: So that you may enjoy easier steering in the LaFayette, it has a feature new in low-priced cars—a worm and roller steering gear

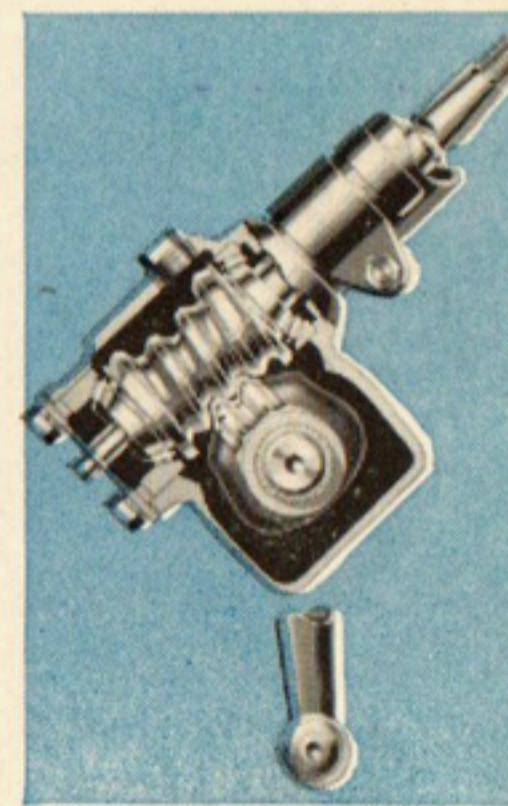

Above: For added safety LaFayette brake bands and drums are unusually wide. And with the new, simplified brake operating mechanism, adjustment of brakes is needed far less frequently

Right: To "dim" the Twin Beam headlamps on the LaFayette, simply push floor button. For full-vision beam, simply push button again

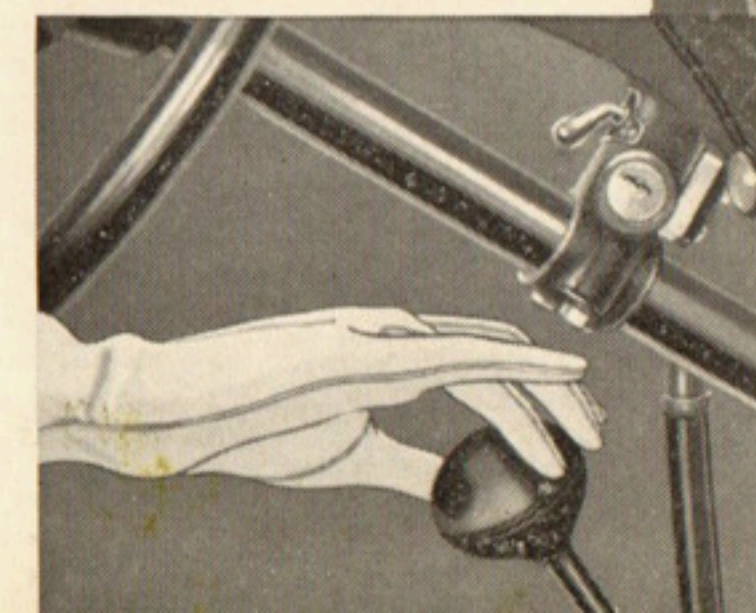
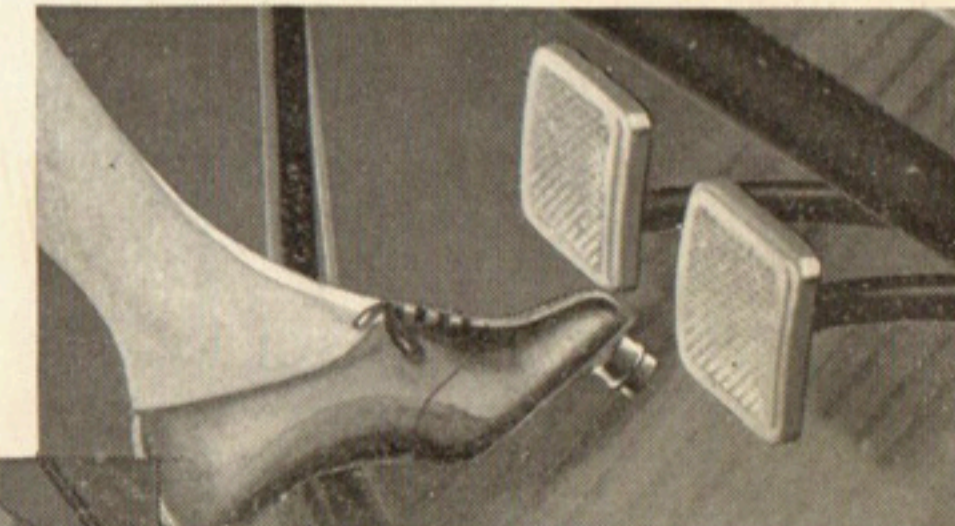

Left: Just a touch of your finger shifts gears in the LaFayette. That's because of the special synchromesh transmission with all helical gears machine-lapped

Specifications

WHEELBASE—113".

ENGINE—6 cylinders, in line; L-Head; high compression, high turbulence. 4-point suspension, mounted on rubber, with additional rubber insulated stabilizer under transmission. 3¼" bore. 4⅜" stroke. 217.76 cubic inches piston displacement. N.A.C.C. rating 25.35 horsepower. Develops 75 horsepower at 3200 R.P.M. actual dynamometer brake test.

IGNITION—Single; 6 Aircraft type spark plugs, one to each cylinder. 6-contact distributor with double breaker arm. Single ignition coil. Coincidental lock.

CRANKSHAFT—Forged steel, integrally counterweighted, 7 main bearings; hollow crankpins; fitted with torsional vibration damper.

MAIN CRANKSHAFT BEARINGS—Steel backed, babbitt lined; 7 in number.

PISTONS—Aluminum alloy with Invar struts to control expansion; 2 compression and 2 oil regulating rings.

CONNECTING RODS—Forged steel with steel caps. Rifle bored for full pressure lubrication direct to piston pins. Connecting rods also drilled for spraying oil onto pressure side of cylinder walls, cams and valve mechanism. Diamond bored upper bronze bushings. Lower bearings steel backed, babbitt lined.

CAMSHAFT—One-piece drop forging; 6 bearings; steel backed, babbitt lined. Camshaft driven by silent timing chain.

VALVES—L-Head. Intake valves, chrome nickel steel. Exhaust valves, chrome nickel silicon steel.

ENGINE LUBRICATION—Gear type oil pump forces oil under pressure to crankshaft main, connecting rod and camshaft bearings, piston pins and timing chain. Oil filter. Crankcase ventilator. Oil pressure gauge on dash.

COOLING SYSTEM—Water circulated by centrifugal pump. Fin and tube radiator. Thermostatic control of water circulation. 4-blade, belt driven steel fan with self-contained lubricating system. Engine water temperature indicator on dash.

FUEL SYSTEM—Gasoline pump driven from camshaft. Gasoline strainer. Air cooled gasoline lines. Electric fuel gauge on dash. Capacity of fuel tank, 16 gallons.

CARBURETOR—Single downdraft type. Automatic accelerating pump. Manual starting choke. Automatic heat control. Air cleaner and intake silencer.

MUFFLER—Improved exhaust silencer; rubber insulated brackets.

BATTERY—Globe, 6-8 volt.

GENERATOR—Third brush type regulation.

STARTER—Bendix improved automatic engagement with starter button on dash.

CLUTCH—Single plate dry disc type.

TRANSMISSION—Synchro Shift type with silent helical type constantly meshed second speed gears and bronze clutch arrangement for synchronizing gear speeds to provide easy silent shifting. 3 speeds forward, 1 reverse.

FREE WHEELING—Selective cam and roller overrunning clutch type; separate unit at rear of transmission case with dash control—optional at extra charge.

FRAME—Rigid X-Dual low double drop frame with long X-type subframe extending from front cross-member to rear kickup. One straight cross-member at front and two at rear.

DRIVE—Hotchkiss type, drive and torque through rear springs. Mechanical type universal joints at front and rear of propeller shaft.

AXLES—Rear: Semi-floating Spiral Bevel Drive type. Front: Drop forged I-beam Reversed-Elliott type. Timken tapered roller bearings in front wheels and throughout rear axle.

BRAKES—Service brakes—4-wheel internal expanding mechanical, equal action, two-shoe single anchor type, cable and conduit operated. Pressed steel brake drums. Parking brake acts on all four wheels.

SPRINGS—Alloy steel; semi-elliptic type, with lubricating inserts; front springs shackled at front end. Spring shackles are self-adjusting threaded type; front ends of rear springs are rubber insulated with durable live rubber bushings, requiring no lubrication or adjustment. Steering road shock eliminator at rear of front spring on steering side. Metal spring covers and threaded type spring shackles have push gun type lubricating fittings.

SHOCK ABSORBERS—Gabriel double acting hydraulic with automatic and thermostatic control which provide for road, load, speed or temperature changes; self-aligning rubber cushioned connecting links.

CHASSIS LUBRICATION—Alemite push gun type.

STEERING GEAR—Worm and roller type, mounted in roller bearings.

WHEELS—5 demountable steel wheels with drop center rims, standard equipment.

TIRES—5.50-17, full balloon, standard; 6.25-16, air wheels at extra charge.

Standard Equipment and Appointments

INSTRUMENTS—Aeroplane type speedometer, translucently lighted; oil pressure gauge, electric gasoline gauge, ammeter and engine water temperature indicator grouped in attractive instrument panel.

CONTROLS—Three-spoke safety steering wheel has steel core encased in hard rubber with horn button in center. Carburetor throttle, choke button and light switch on instrument board. Coincidental ignition and steering gear lock on steering gear post bracket. Headlamp dimmer control button on toe board at left of clutch pedal. Rubber covered pads on brake and clutch foot pedals. Rubber covered treadle type accelerator. Gear shift lever extended forward through center of floor board. Parking brake lever conveniently located forward at left of driver.

BODIES—Seaman "Slip-Stream" composite hardwood and steel bodies, thoroughly insulated against heat, cold and noise.

VENTILATING SYSTEM—All models have an improved and simplified type Quiet Draftless Clear Vision ventilating system with patented air vents in front door windows of all models including rear quarter windows of 4 Door Sedan. It provides draftless ventilation without dividing the glass or obstructing vision through the window.

STANDARD EQUIPMENT—Safety glass in windshield. Large

package compartment and disappearing ash receiver on instrument board. Vacuum windshield wiper. Adjustable inside sunshade. Non-glare rear view mirror. Built-in radio aerial. Tool kit. Twin beam double filament bulb headlamps. Twin combined stop and tail lights with safety red reflex reflector lenses. Horn located under hood.

Interior hardware, bright nickel finished with ivory colored escutcheon plate centers and window lift crank handle knobs. Exterior hardware, chromium-plated. Remote control inside safety locking door handles on all doors. Finger-tip control easy sliding type adjustable driver's seat. Large ventilator on top of cowl, with operating lever directly underneath instrument board. Hoods have ventilating doors and concealed catches with one remote control handle on each side. Steel, completely rubber covered running boards.

UPHOLSTERY—Broadcloth standard, mohair or leather optional at extra charge.

APPOINTMENTS—The 4 Door Sedan has rear seat side arm rests, ash receivers, assist cords, dome light, foot rail, robe cord, large shirred pocket on back of front seat, and curtains on back and rear quarter windows.

The 2 Door Sedans have rear seat side arm rests, ash receivers, dome light, curtain on back window, and assist cord and large pocket on right side.

The 2 Door Touring Sedan has a large built-in rear trunk.

All Coupes have a dome light, rear window curtain, and a locking handle on rear deck compartment door. The 4-passenger Coupe has a leather upholstered rumble seat and an adjustable rear window.

REGULAR FACTORY EQUIPMENT—Bumpers with upright guards (front and rear), metal spring covers, spare tire, metal tire cover and spare wheel lock are regular factory equipment at extra charge, included in delivered price of car.

OPTIONAL FACTORY EQUIPMENT AT EXTRA CHARGE—Individually sprung front wheels, safety glass ventilator wings, safety glass in all windows, Free-Wheeling, special tires, detachable trunk, radio, hot water heaters and other Nash-La Fayette Approved accessories available.

ROYAL EQUIPMENT—All models except those with standard built-in trunk: 2 spare wheels mounted in front fender wells, 2 spare tires, 2 wheel locks, 2 metal tire covers and a folding rear trunk rack.

REGAL EQUIPMENT—All models with standard built-in trunk: Same as Royal Equipment except that there is no folding trunk rack included.

CROWN EQUIPMENT—All Models: The one spare demountable wheel is mounted in right hand side front fender well, plus a folding trunk rack on models not equipped with a built-in trunk.

DE LUXE EQUIPMENT—All Models: De Luxe instrument panel with electric clock, cigar lighter; extra sunshade, extra windshield wiper, chromium plated headlamps and tail lamps and 2 chromium plated horns mounted under headlamps.

Wheel Base	MODELS	
	Standard	De Luxe
113"	5 Pass. 4 Door Sedan	5 Pass. 4 Door Sedan
	2 Pass. Coupe	2 Pass. Coupe
	4 Pass. Coupe Rumble Seat	4 Pass. Coupe Rumble Seat
	5 Pass. 2 Door Touring Sedan	5 Pass. 2 Door Touring Sedan
	5 Pass. 2 Door Sedan	5 Pass. 2 Door Sedan

The Nash Motors Co. reserves the right to make any changes in specifications or prices without incurring any obligation to have same apply on cars previously sold.



LAFAYETTE

NASH - BUILT